

C-G7/G72

SERVICE MANUAL

Illustration is C-G7.

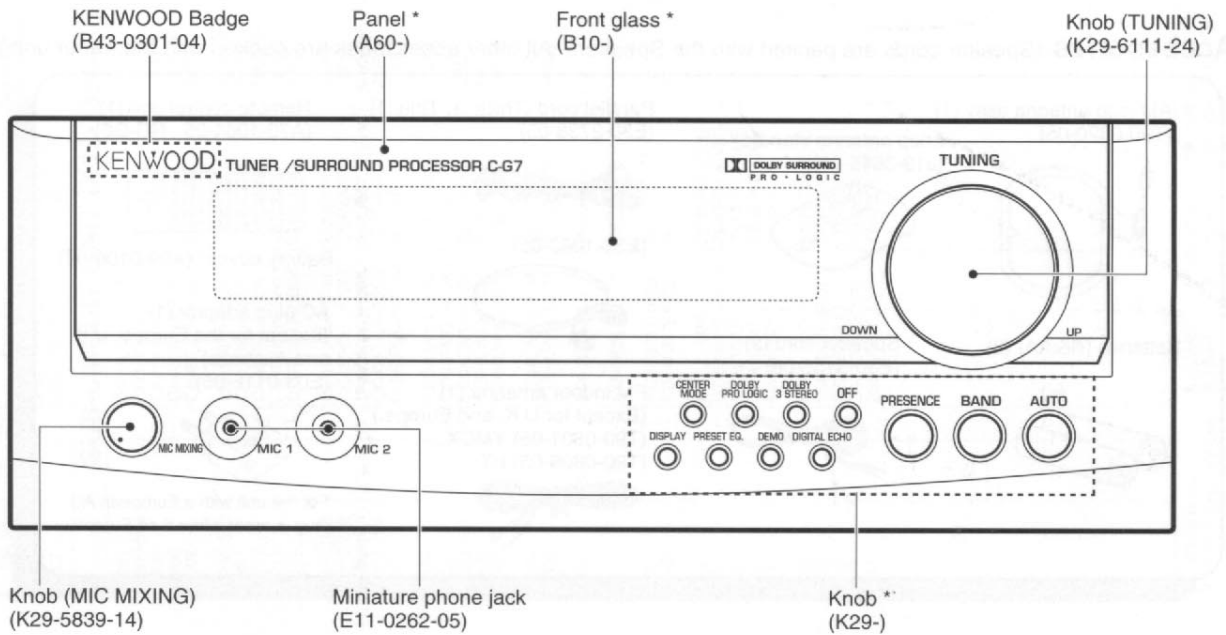
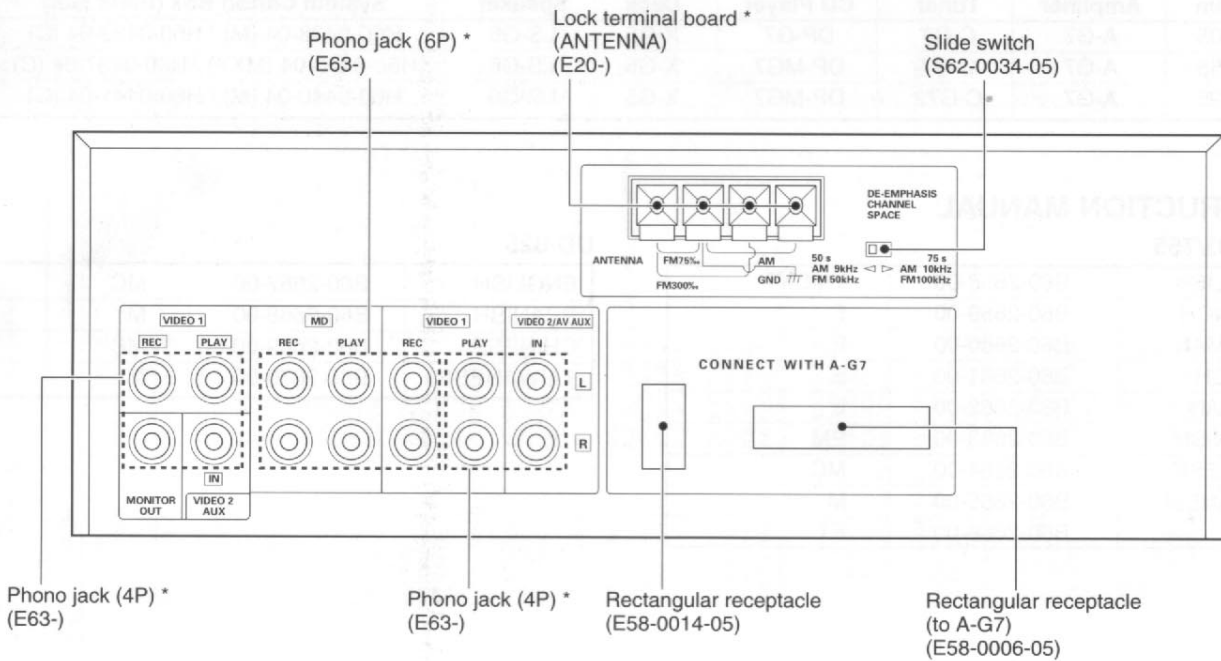

Illustration is C-G7/G72.



PRECAUTIONS FOR REPAIR

C-G7/G72 do not have a power supply transformer. Use A-G7 or PS-94UA power supply to supply power.

* Refer to parts list on page 26.

C-G7/G72

EXTERNAL VIEW / REMOTE CONTROL

Illustration is C-G72.

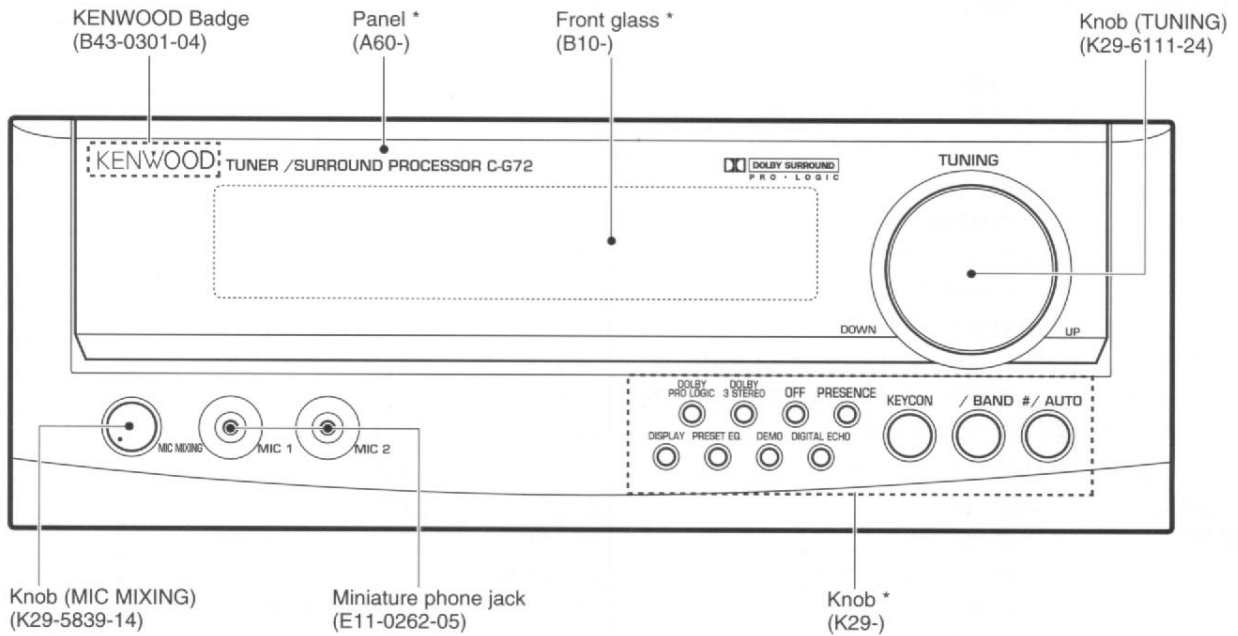

* Refer to parts list on page 26.

Remote control

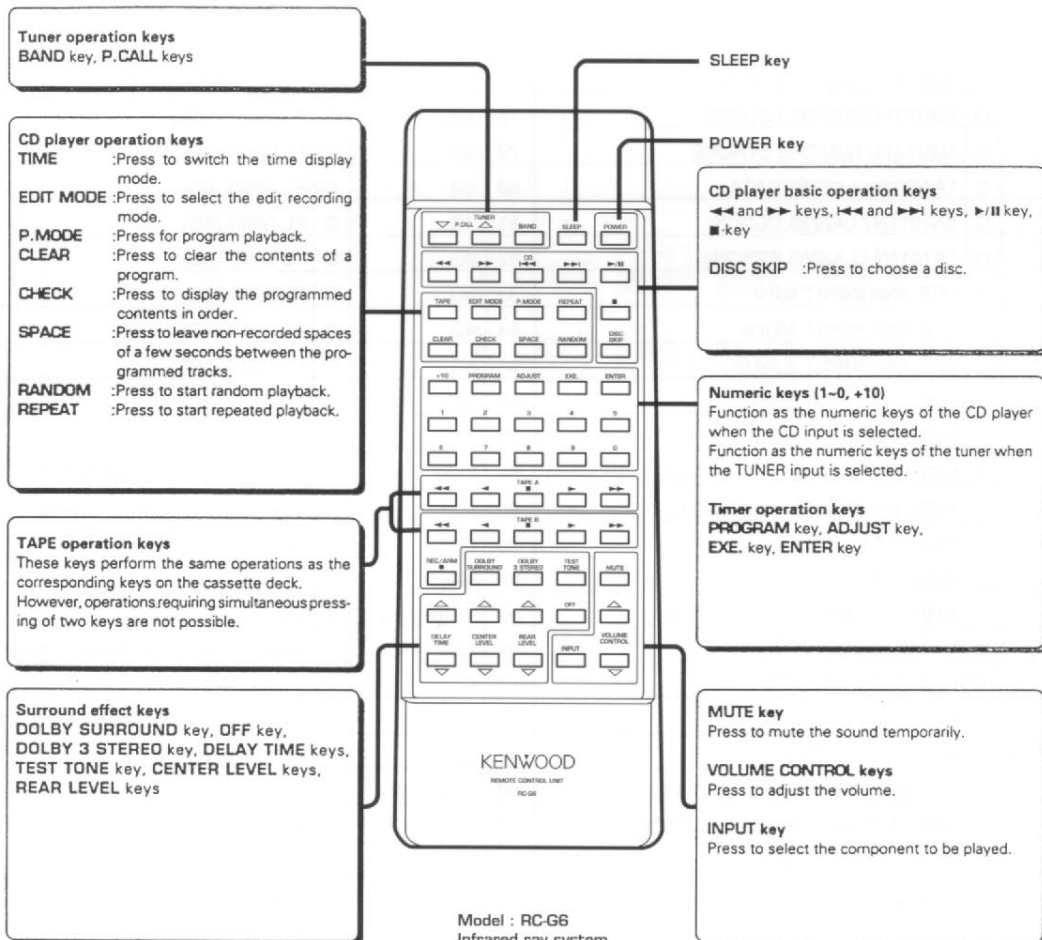

BLOCK DIAGRAM

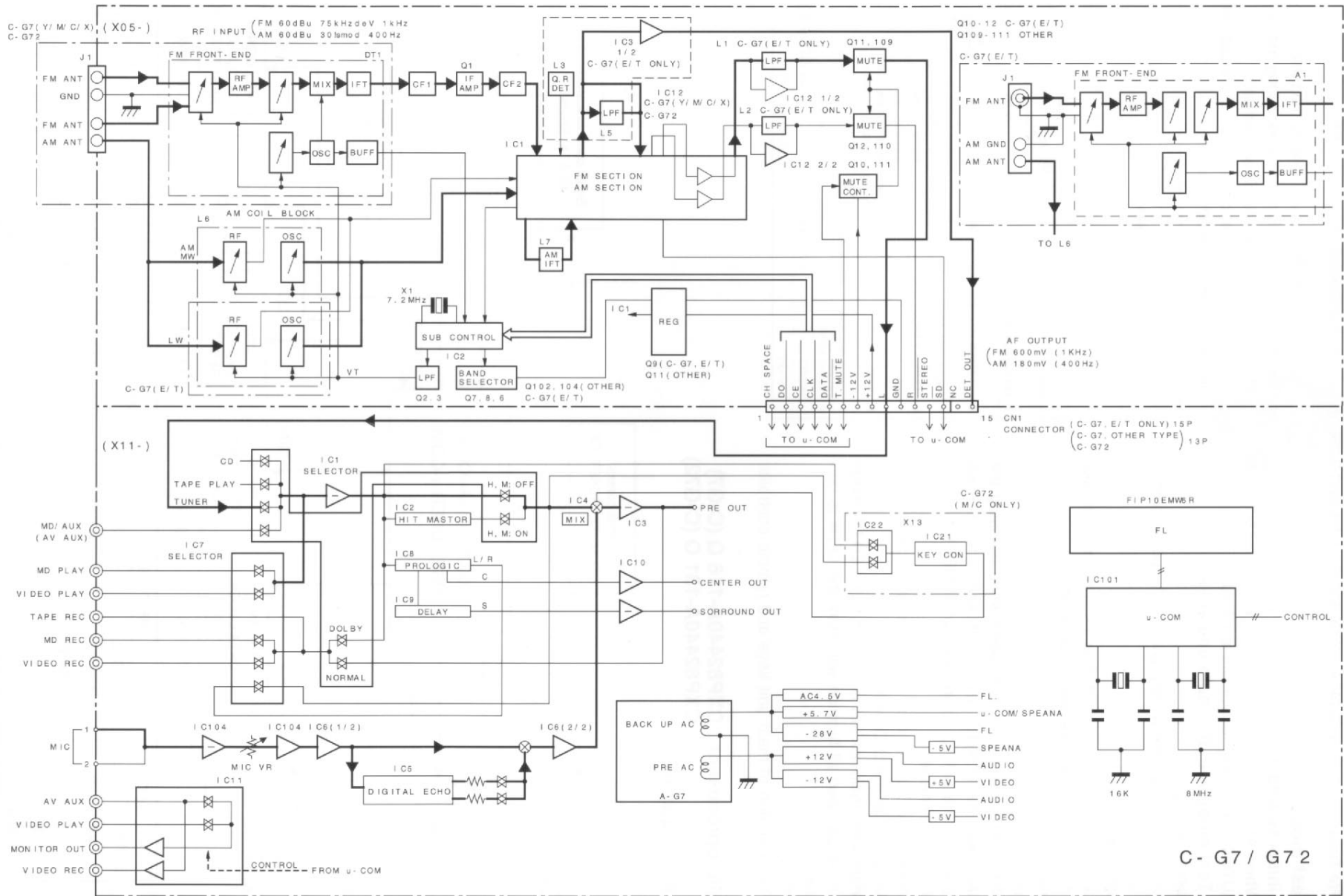

C- G7 / G72

CIRCUIT DESCRIPTION

For Pre Tuner μ -com CXP82440A-XXXX, Initial status and Back-up, refer to the Service Manual of C-F5

1. Test mode

1-1. Initial setting

- When AC power cord is plugged while pressing the AUTO/MANUAL key, equipment is initialized.

1-2. Test mode with the main unit keys

(1) Setting procedure

While pressing the BAND key, plug the AC power cord to the power outlet.

(2) Cancellation

Unplug the AC power cord. The initial setting will take effect and the test mode will be canceled.

(3) Description

1. Auto POWER ON

- When AC power cord is plugged while pressing the BAND key, the POWER will turn ON and all function will be at the initial setting. (Input selector=TUNER)

2. ALL LED ON mode

- When the AC power cord is plugged while pressing the BAND key, all the LEDs will turn ON.
- When some main unit key is pressed, ALL LED ON mode will be canceled all function will return the LEDs to normal.

3. Others

- The operation of main unit keys and remote controller

keys during the test mode, refer to the table.

- The MUTE function does not work during the test mode. (When POWER ON, MUTE is effective.)
- Test mode is not canceled when the input selector is moved TUNER to another source.

Key	Description		
	Selector : TUNER	Selector : Except for TUNER	
		KEY CON. OFF	KEY CON. ON
1 AUTO/#	Normal operation	REAR LEVEL Min → Center → Max ↑	Normal operation (KEY CON. UP)
2 BAND/b	Normal operation	CENTER LEVEL Min → Center → Max ↑	Normal operation (KEY CON. DOWN)
3 KEY CON ON/OFF	Inhibit	KEY CON. ON	KEY CON. OFF
4 PRESENCE	P.CALL DOWN	Normal operation	Normal operation (HIT MASTER ON/OFF)
5 DOLBY PRO LOG	Normal operation		
6 DOLBY 3 STEREO	Normal operation		
7 OFF	Normal operation		
8 DEMO	[FREQUENCY → TAPE → MD] [CD → VIDEO2 → VIDEO1]		
9 TUNING UP/DOWN	Normal operation	Inhibit	
10 DIGITAL ECHO	Normal operation		
11 PRESET EQ.	P.CALL UP	Normal operation	
12 DISPLAY	ALL LEDS ON ↔ OFF		

2. Microprocessor : CXP82440A-116 Q (C-G7) : CXP82440A-131 Q (C-G72)

2-1. Block diagram

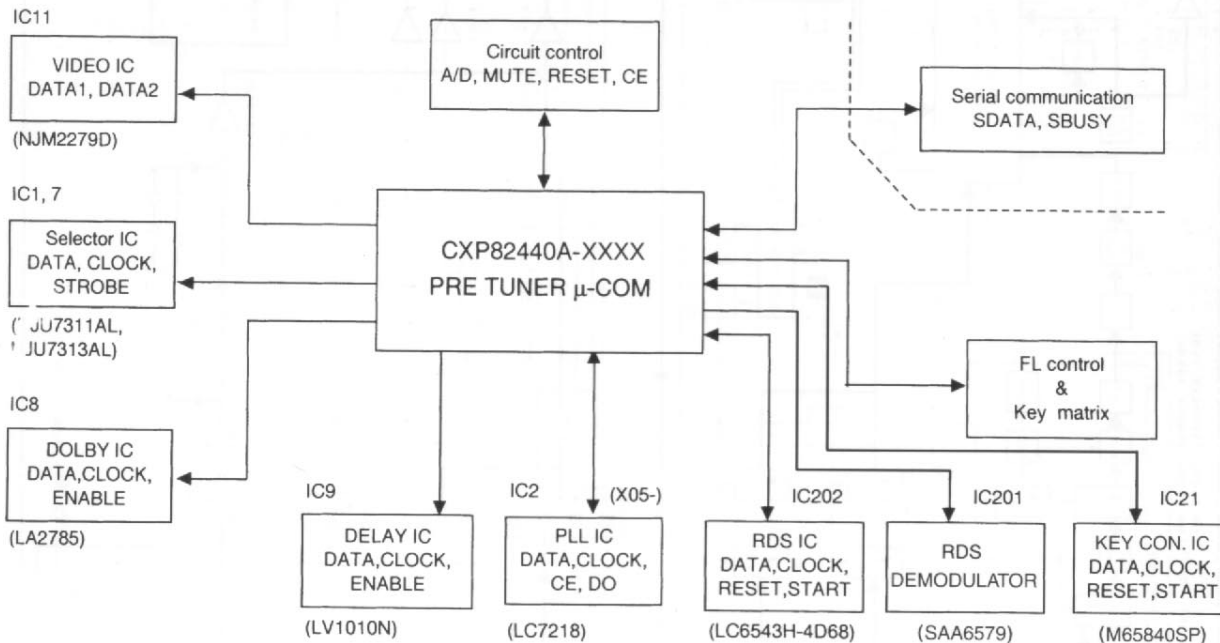

RETURN SCAN	KR 0 (19)		KR 1 (18)	KR 2 (17)	KR 3 (16)
	C-G72	C-G7			
KS 0 (68)	#/AUTO	AUTO	PRESENCE	DEMO	---
KS 1 (69)	b/BAND	BAND	OFF	PRESET EQ.	DISP
KS 2 (70)	KEY CON.	CENTER MODE	3 STEREO	ECHO	SURROUND
DS 0 (71)	DSW0 (D37)		---	DSW2 (D39)	---

C-G7/G72

CIRCUIT DESCRIPTION

2-3. Pin description

No.	Name	I/O	Description	No.	Name	I/O	Description
1	CK	I	LC6543H-4600 CLOCK	50	P17	O	FL SEGMENT (P17)
2	DT	I	LC6543H-4600 DATA	51	P18	O	FL SEGMENT (P18)
3	ENCA	I	ROTARY ENCODER A SIGNAL	52	P19	O	FL SEGMENT (P19)
4	ENCB	I	ROTARY ENCODER B SIGNAL	53	P20	O	FL SEGMENT (P20)
5-6	NC	I	NOT USED	54	P21	O	FL SEGMENT (P21)
7	NC	I	16K ADJUST MODE	55	P22	O	FL SEGMENT (P22)
8	S.DATA	I/O	SERIAL DATA	56	P23	O	FL SEGMENT (P23)
9	S.BUSY	I/O	SERIAL BUSY	57	P24	O	FL SEGMENT (P24)
10	K CON. DT	O	KEY CON. DATA	58	P25	O	FL SEGMENT (P25)
11	V.MUTE	O	VIDEO MUTE (H:MUTE OFF, L:MUTE ON)	59	P26	O	FL SEGMENT (P26)
12	T.MUTE	O	TUNER MUTE (H:MUTE OFF, L:MUTE ON)	60-63	NC	O	NOT USED
13	K CON. CK	O	KEY CON. CLOCK	64	P1	O	FL SEGMENT (P1)
14	K CON. ST	O	KEY CON. STROBE	65	P2	O	FL SEGMENT (P2)
15	NC	O	NOT USED	66	P3	O	FL SEGMENT (P3)
16	KR 3	I	KEY RETURN 3	67	P4	O	FL SEGMENT (P4)
17	KR 2	I	KEY RETURN 2	68	P5/KS 0	O	FL SEGMENT (P5) / KEY SCAN 0
18	KR 1	I	KEY RETURN 1	69	P6/KS 1	O	FL SEGMENT (P6) / KEY SCAN 1
19	KR 0	I	KEY RETURN 0	70	P7/KS 2	O	FL SEGMENT (P7) / KEY SCAN 2
20	ST	I	STEREO / MONORAL (H:MONORAL, L:STEREO)	71	P8/DS 0	O	FL SEGMENT (P8) / KEY SCAN 3
21	SD	I	SD SIGNAL (H:NO TUNED, L:TUNED)	72	P9	O	FL SEGMENT (P9)
22	PLLDO	I	LC7218 DO	73	P10	O	FL SEGMENT (P10)
23	PLLCK	O	LC7218 CLOCK	74	P11	O	FL SEGMENT (P11)
24	PLLCE	O	LC7218 CE	75	P12	O	FL SEGMENT (P12)
25	PLLDT	O	LC7218 DATA	76	P13	O	FL SEGMENT (P13)
26	SELDT	O	NJU7311/ NJU7313 DATA	77	P14	O	FL SEGMENT (P14)
27	SELCK	O	NJU7311/ NJU7313 CLOCK	78	10G	O	FL GRID (10G)
28	SELST	O	NJU7311/ NJU7313 STROBE	79	9G	O	FL GRID (9G)
29	SURRDT	O	LA1011N / LA2785 DATA	80	8G	O	FL GRID (8G)
30	SURRCK	O	LA1011N / LA2785 CLOCK	81	7G	O	FL GRID (7G)
31	SURRST	O	LA1011N / LA2785 STROBE	82	6G	O	FL GRID (6G)
32	A/D	I	SPE-ANA INPUT 63Hz	83	5G	O	FL GRID (5G)
33	A/D	I	SPE-ANA INPUT 400Hz	84	4G	O	FL GRID (4G)
34	A/D	I	SPE-ANA INPUT 2.5kHz	85	3G	O	FL GRID (3G)
35	A/D	I	SPE-ANA INPUT 16kHz	86	2G	O	FL GRID (2G)
36	NC	I	NOT USED	87	1G	O	FL GRID (1G)
37	CE	I	μ -COM CHIP ENABLE (H:ENABLE, L:DISABLE)	88	Vfdp		-30V (μ -COM POWER SUPPLY)
38	RESET	I	RESET (μ -COM HARD RESET)	89	Vdd		+5V (μ -COM POWER SUPPLY)
39	EXTAL	I	8MHz CERAMICS	90	NC		NOT USED
40	XTAL	O	8MHz CERAMICS	91	Vss		GND (μ -COM POWER SUPPLY)
41	Vss		GND (μ -COM POWER SUPPLY)	92	TYPE SEL	I	MODEL DETECTION (NORMAL : HI)
42	TX	O	32.768 kHz CRYSTAL	93	RES SEL	I	16kHz RESONANCE (H:NORMAL, L: 16 kHz RESONANCE)
43	TEX	I	32.768 kHz CRYSTAL	94-95	NC	I	NOT USED
44	NC	I	NOT USED	96	POWER	O	POWER (H:POWER ON, L:POWER OFF)
45	K. CON ON/OFF	I	KEY CON. ON/OFF	97	DS1	I	DIODE SWITCH 1
46	AVref		+5V (A/D REFERENCE VOLTAGE)	98	VIDEOSW	O	VIODE SWITCH (H:VIDEO2, L:VIDEO1)
47	AVss		GND (A/D REFERENCE VOLTAGE)	99	HIT.M ON/OFF	O	HIT MASTER ON/OFF
48	P15	O	FL SEGMENT (P15)	100	START	I	LC6543H-4600 START
49	P16	O	FL SEGMENT (P16)				

ADJUSTMENT

X05-4532-7X(E,T type)

No.	ITEM	INPUT SETTINGS	OUTPUT SETTINGS	TUNER SETTING	ALIGNMENT POINTS	ALIGN FOR	FIG.
FM SECTION SELECTOR : FM							
1	DISCRIMINATOR	(A) 98.0MHz 1kHz, ±40kHz dev 60dBμ(ANT input)	Connect a DC voltmeter between TP3 and TP4. (X05-)	AUTO or MONO 98.0MHz	L3 (X05-)	0V	
2	DISTORTION (STEREO)	(C) 98.0MHz 1kHz, ±40kHz dev Pilot : ±6kHz dev. 60dBμ(ANT input)	(B) Lch-out : W35 Rch-out : W40	AUTO 98.0MHz	IFT (W02-)	Minimum distortion.	

X05-446XX-XX(Other countries)

No.	ITEM	INPUT SETTINGS	OUTPUT SETTINGS	TUNER SETTING	ALIGNMENT POINTS	ALIGN FOR	FIG.
FM SECTION Unless otherwise specified, the individual switches should be set as following : BAND : FM							
1	DISTORTION (STEREO)	(C) 98.0MHz 1kHz, ±67.5kHz dev Selector : L or R 60dBμ(ANT input)	(B) Lch-out : W41 Rch-out : W40	AUTO 98.0MHz	IFT (W02-)	Minimum distortion.	

C-G7/G72

ADJUSTMENT

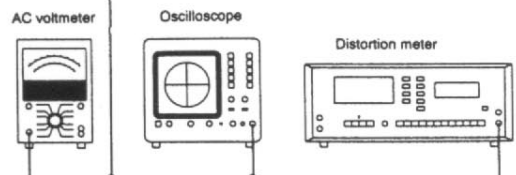
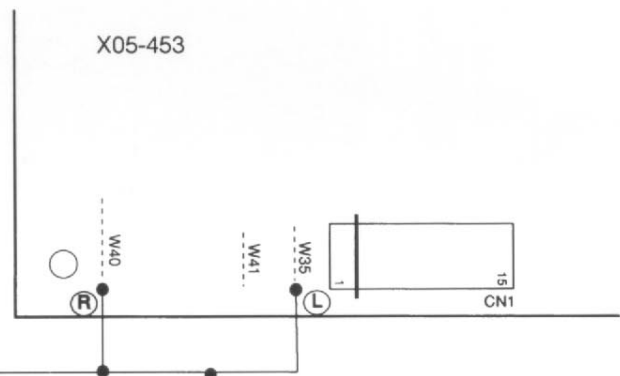
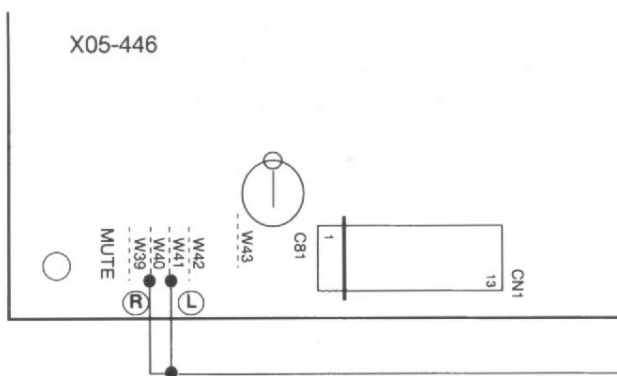
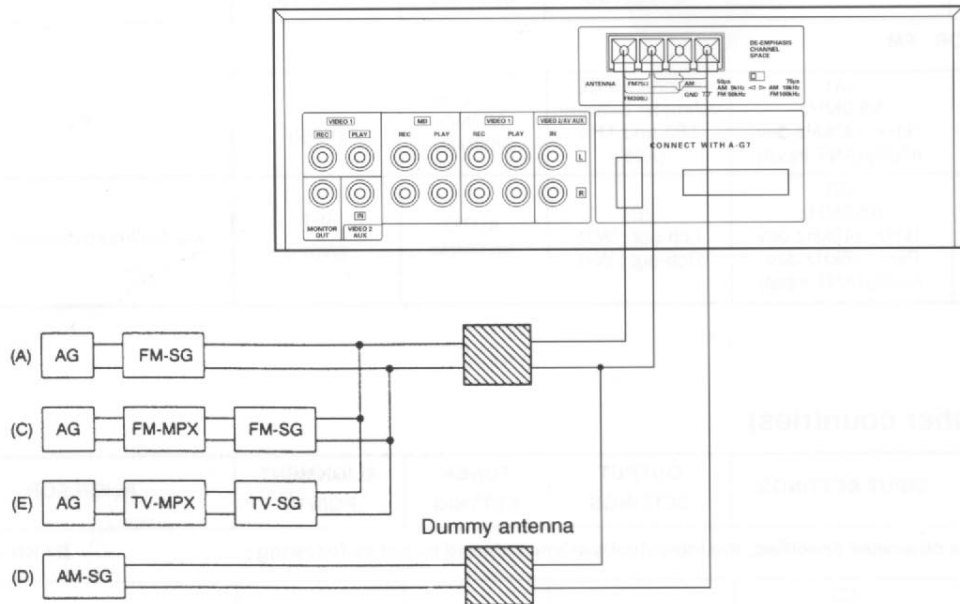

PC BOARD (Component side view)

TUNER UNIT (X05-4460-71 : X / 0-21 : M, Y, C)

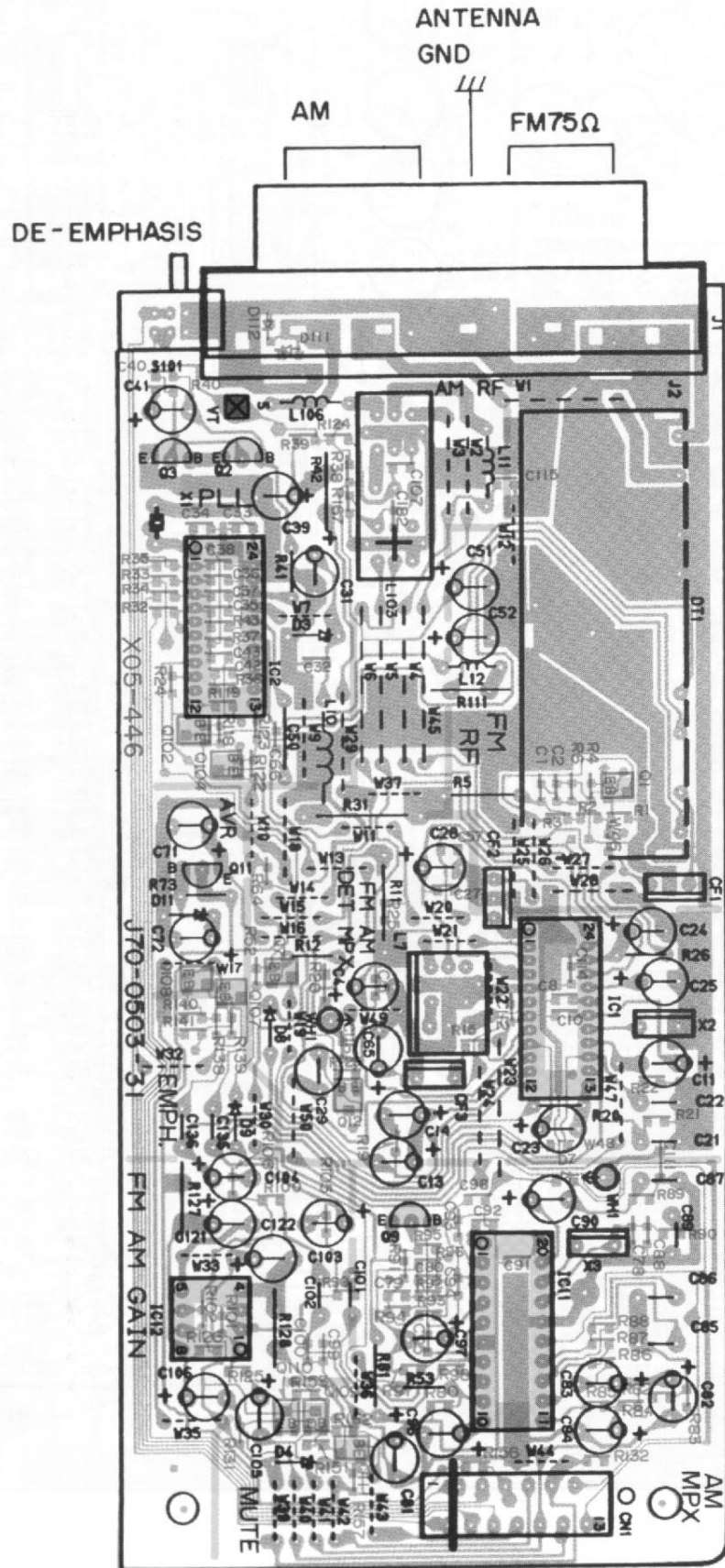

Refer to the schematic diagram for the values of resistors and capacitors.

TUNER UNIT (X05-4532-72 : E / 2-73 : T)

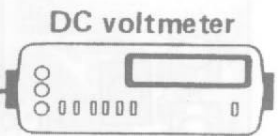
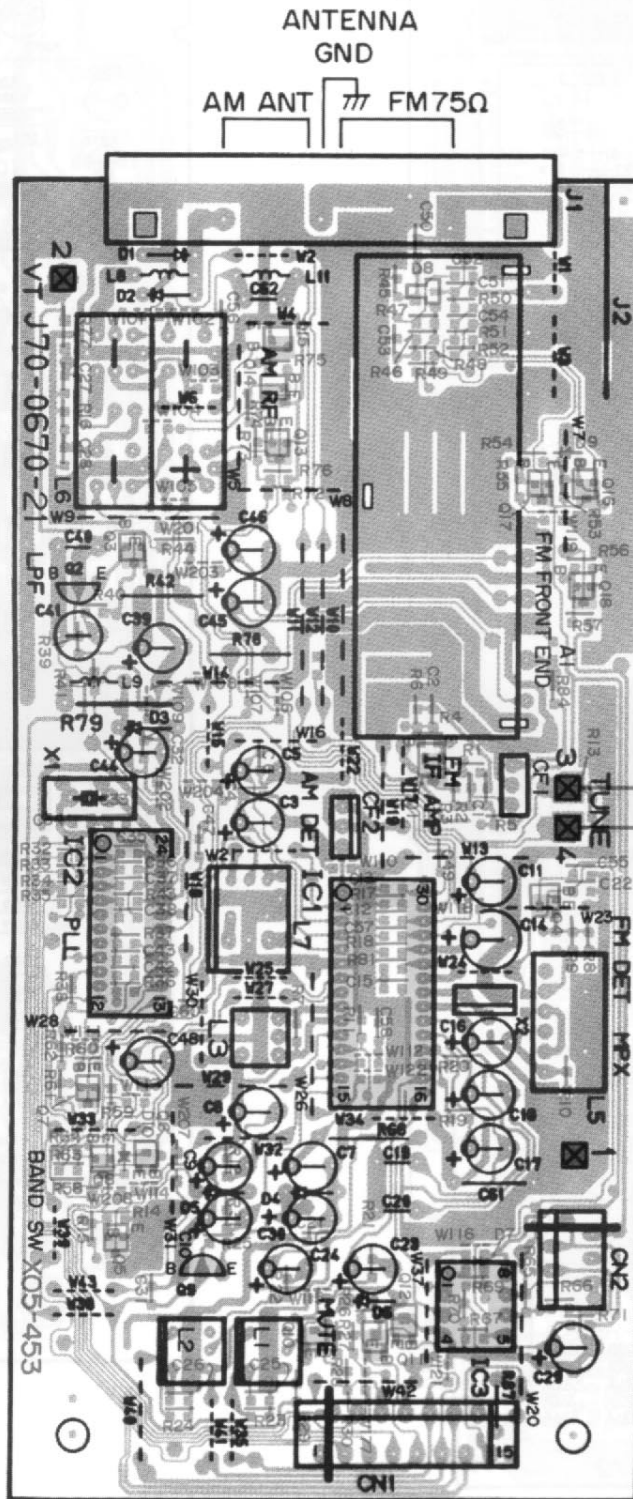

(a) Detector : 0V

PC BOARD (Component side view)

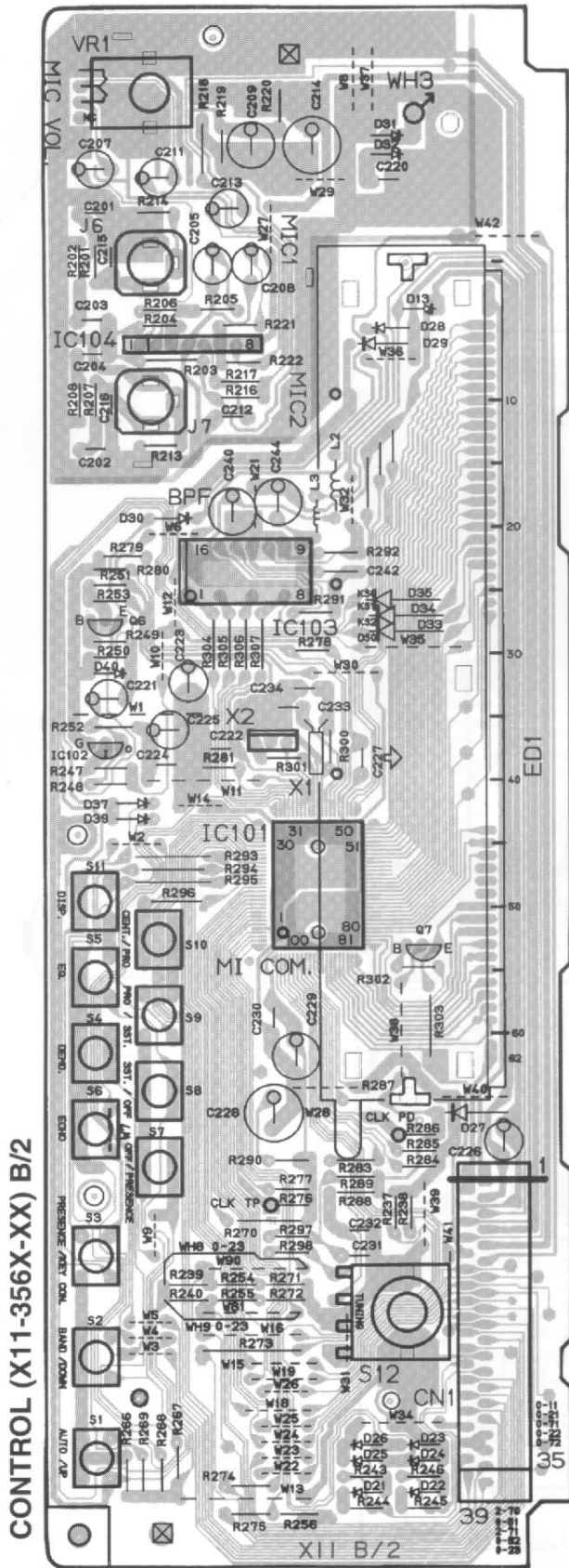

FRONT

SUB CONTROL (X13-7390-20)

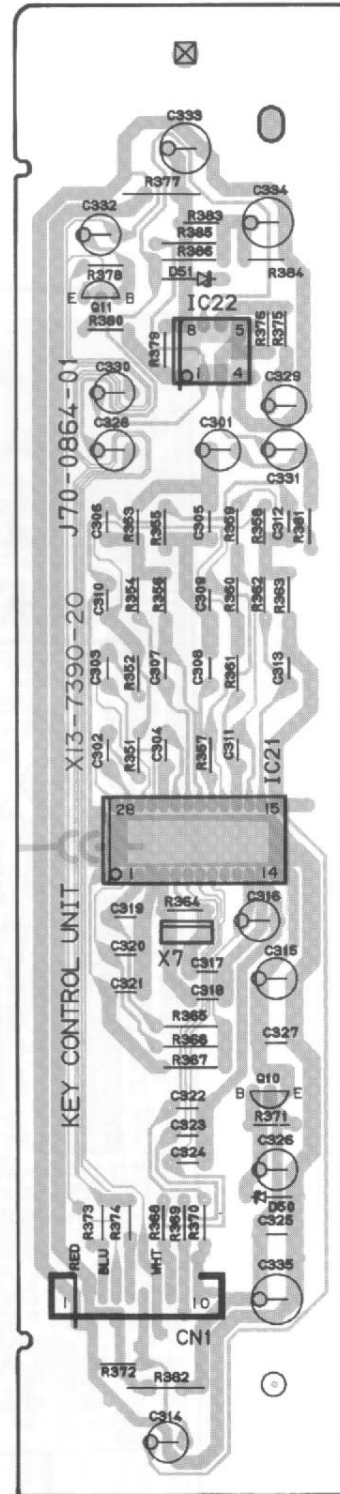

CONTROL



CONTROL (X11-356X-XX) A/2

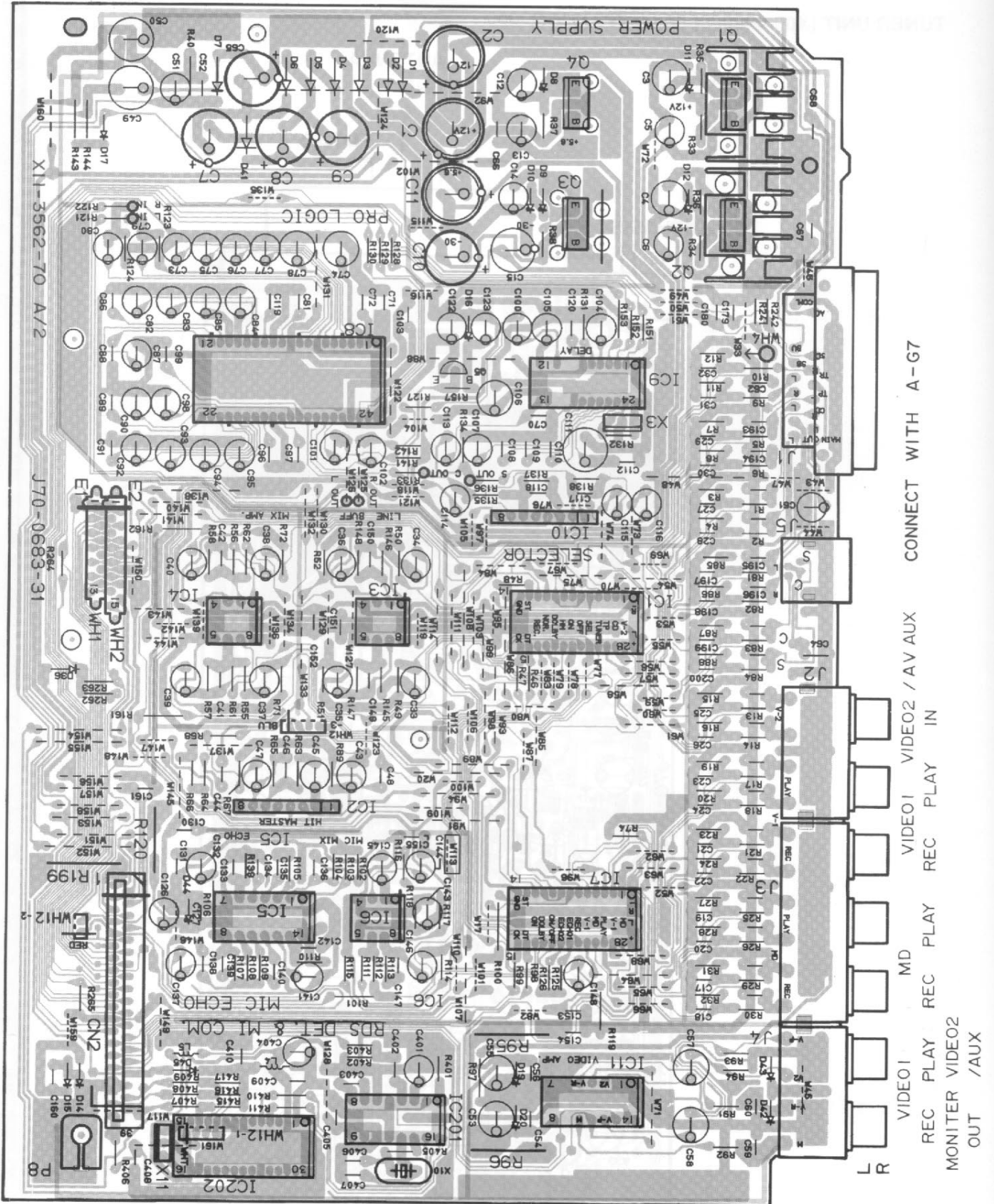

CONNECT WITH A-G7
 VIDEO1 VIDEO2 / AV AUX
 REC PLAY IN
 MD REC PLAY REC PLAY
 VIDEO1
 REC PLAY REC PLAY REC PLAY
 MONITOR VIDEO2
 OUT / AUX

X05-4460-21 (Y, M, C) X05-4460-71 (X)

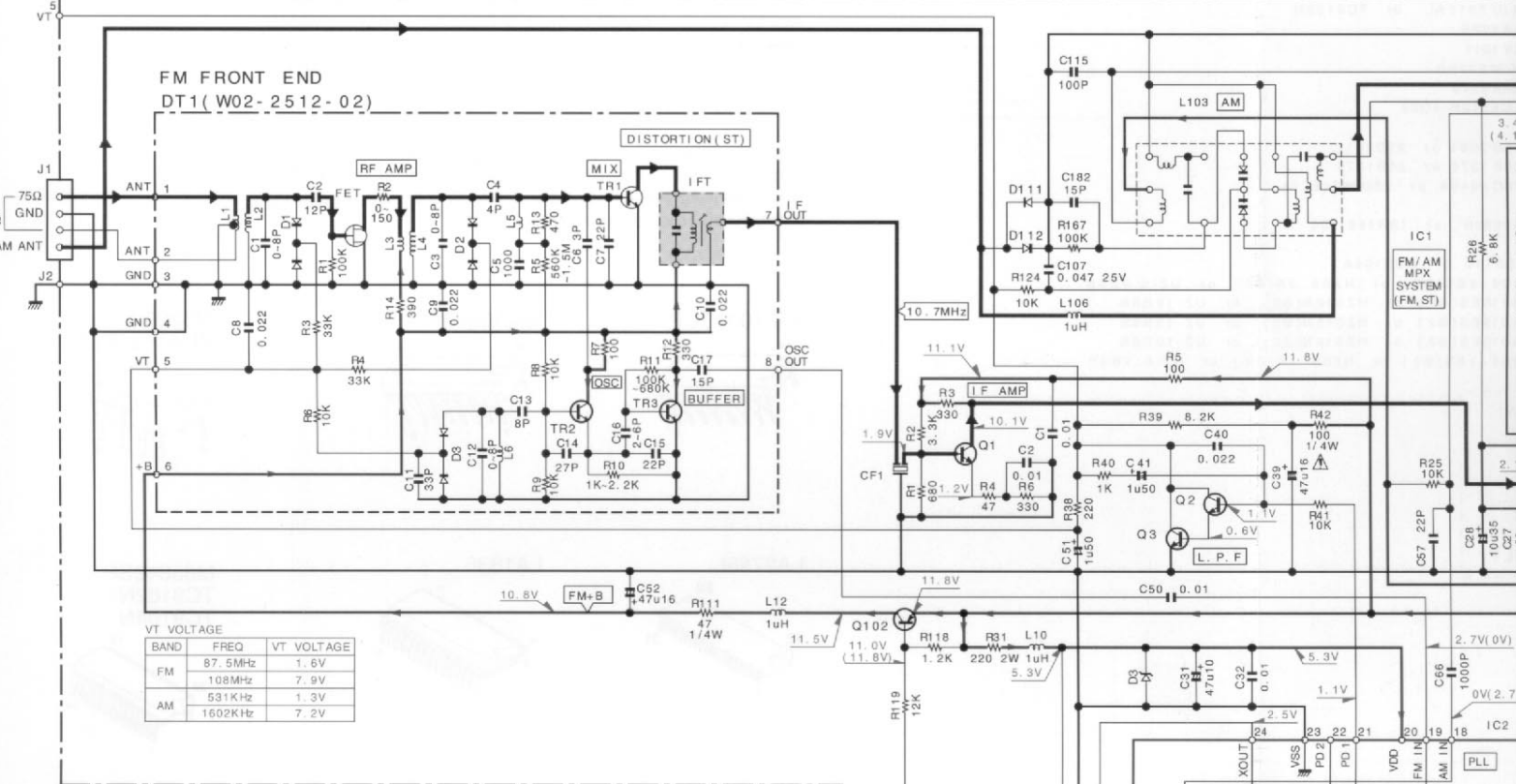

X05-4532-72 (E) X05-4532-73 (T)

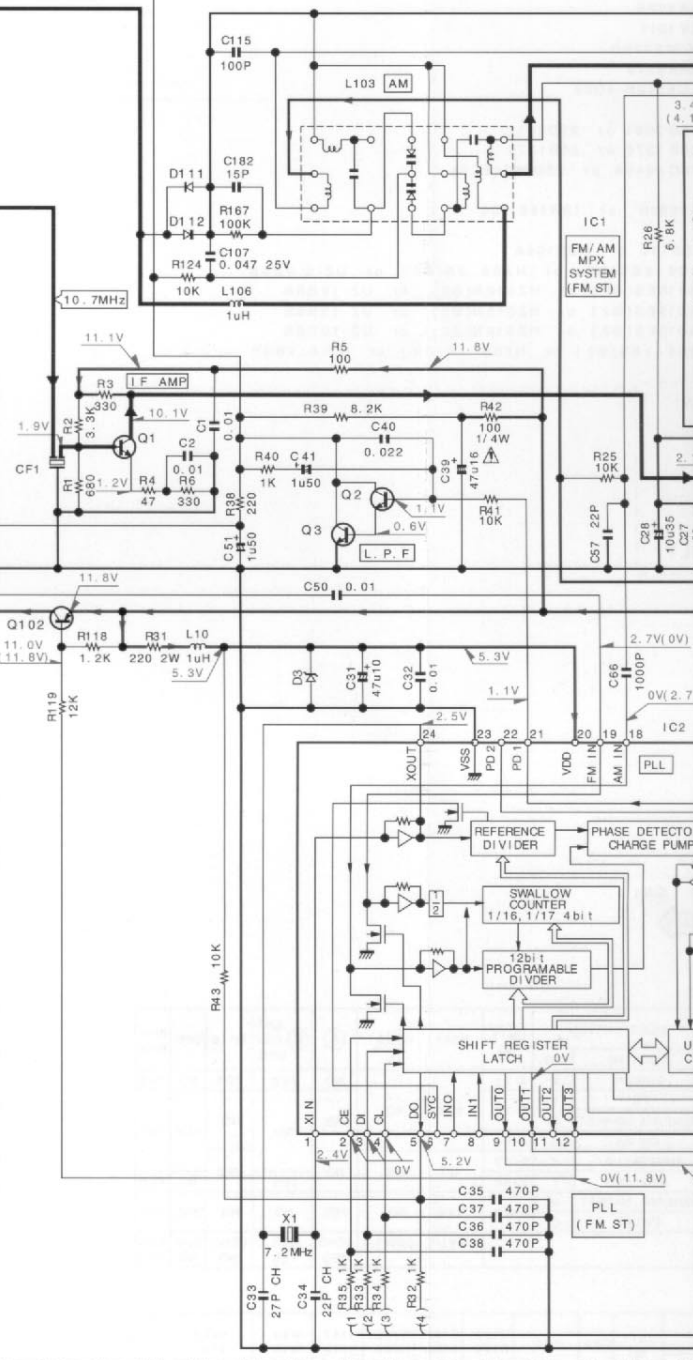
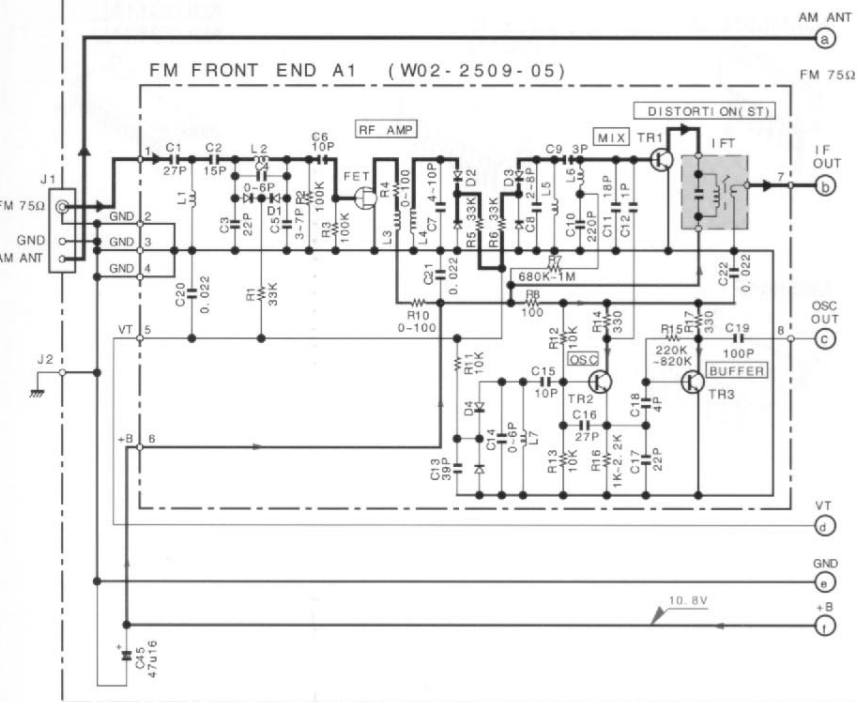

- IC1 : LA1831A-KEN
- IC2 : LC7218
- IC12 : NJM4565D
- Q1 : 2SC2714 (R, O)
- Q2 : 2SC1845 (F, E)
- Q3 : 2SC1740S (Q, R) or 2SC2785 (F, E)
- Q7, 107-110 : 2SC2412K
- Q11 : 2SD863 (E, F)
- Q102, 104, 111 : 2SA1037K
- D3 : HZS5.1N
- D4 : HZS3.3N
- D7, 111, 112 : MA110
- D8 : HSS104
- D11 : HZS8.2N

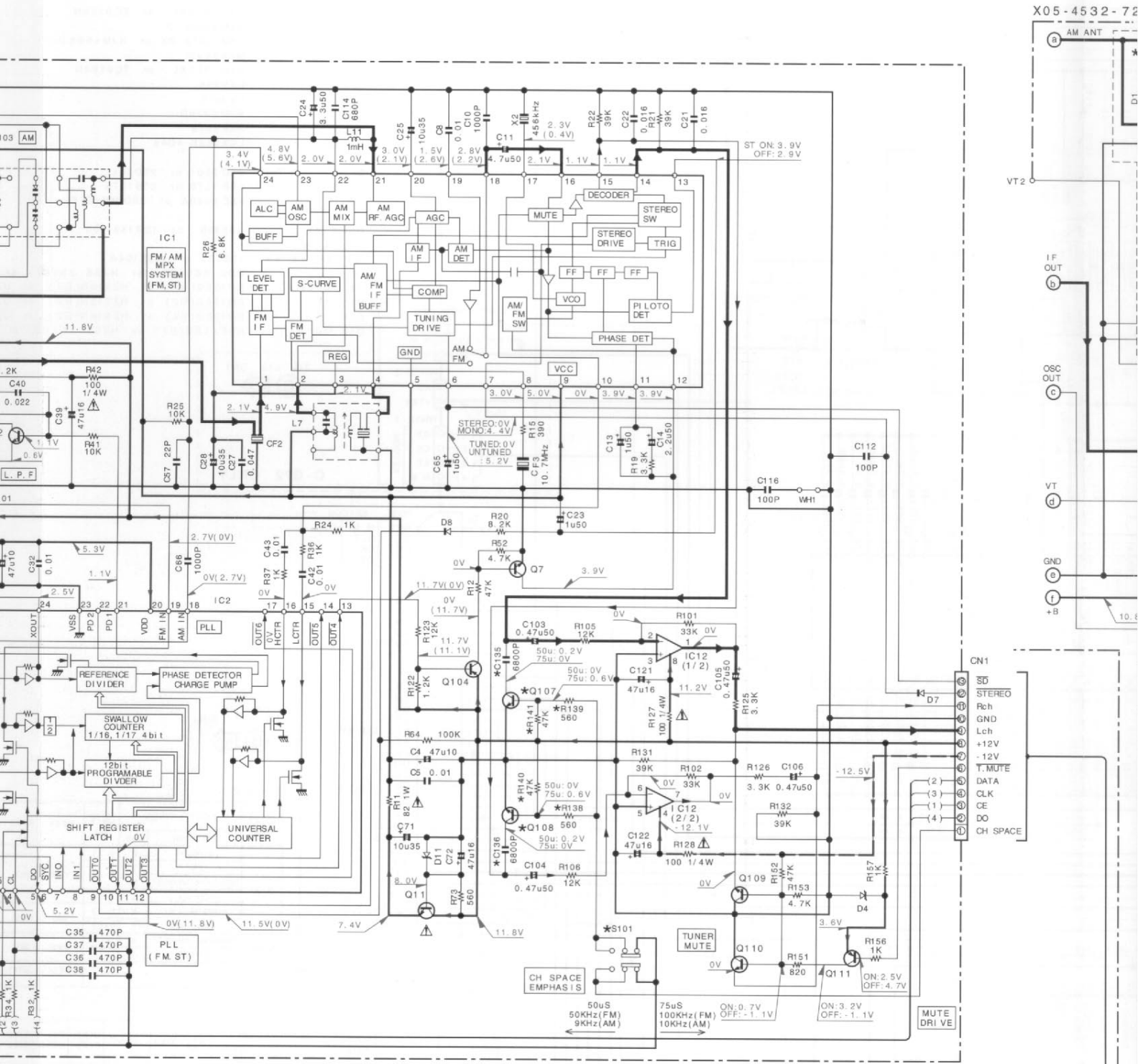

X05-4532-72

- D3 : HZS5. 1N(B2) or RD5. 1ES(B2) or UZ-5. 1BSB
- D4 : HZS3. 3N(B2) or RD3. 3ES(B2) or UZ-3. 3BSB
- D7, 111, 112 : MA110
- D8 : HSS104 or 1SS133
- D11 : HZS8. 2N(B2) or RD8. 2ES(B2) or UZ-8. 2BSB

	UNI T	ABB	Q107, 108	C135, 136	R138-141	S101
X05-4460-XX	0-21	Y, M, C	YES	YES	YES	YES
	0-71	X	NO	NO	NO	NO

05-4532-72 (E) X05-4532-73 (T)

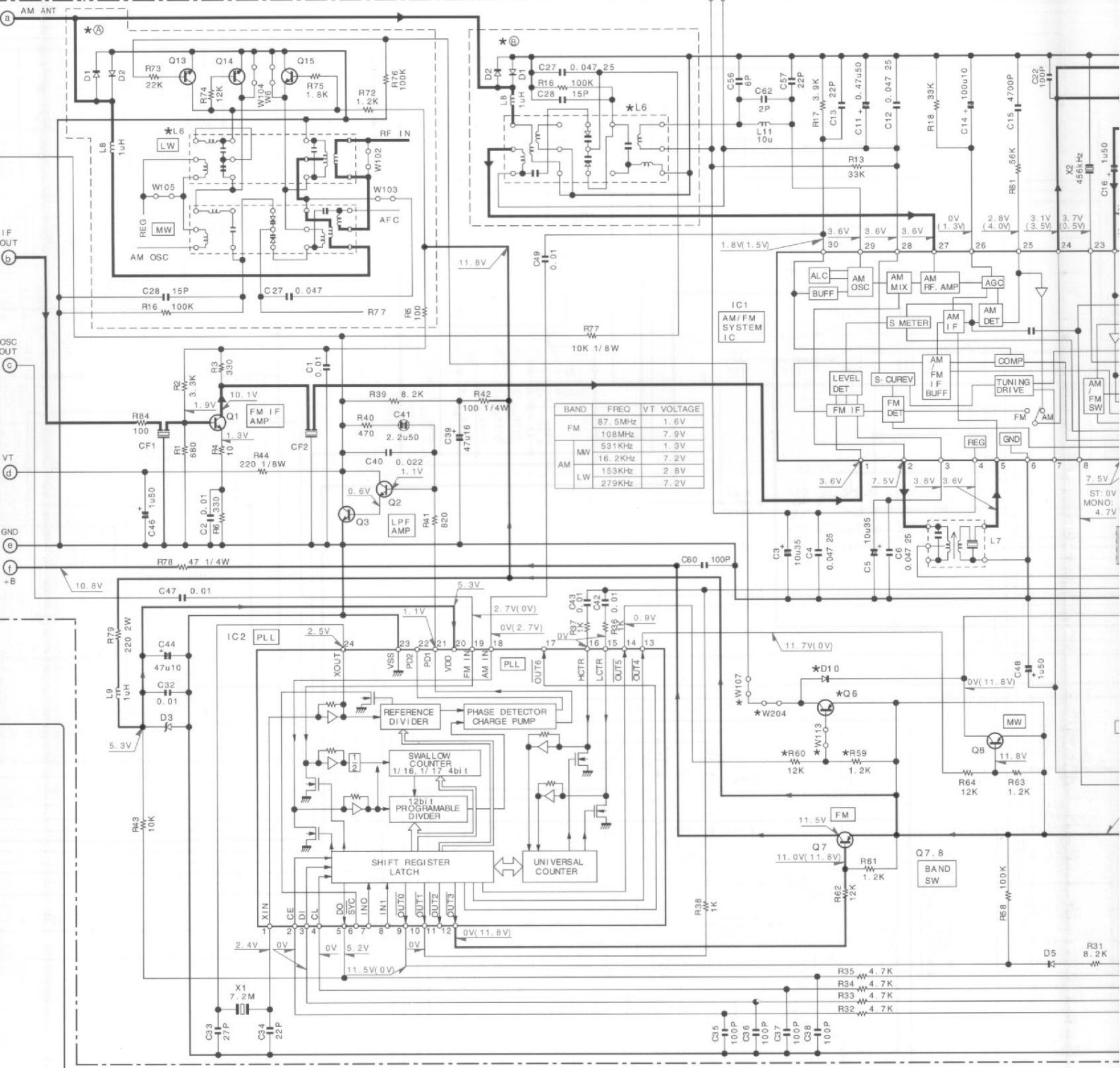

- IC1 : LA1836
- IC2 : LC7218
- IC3 : MS223P
- Q1 : 2SC2714 (R, O)
- Q2 : 2SC1845 (F, E)
- Q3, 4, 5, 13-15 : 2SC4081 (R, S)
- Q6, 7, 8, 10 : 2SA1576 (R, S)
- Q9 : 2SD863 (E, F)
- Q11, 12 : 2SD1757K
- D1, 2, 5 : 1SS133 or HSS104
- D3 : MTZJ5.1(B) or RD5.1ES(B2) or UZ-5.1BSB
- D4 : MTZJ8.2(B) or RD8.2ES(B2) or UZ-8.2BSB
- D6 : MTZJ3.3(B) or RD3.3ES(B2) or UZ-3.3BSB
- D10 : MA110

	UNIT	ABB		L6
X05-4532-7X	2-72	E	(B)	L39-1328
	2-73	T	(A)	L39-1325

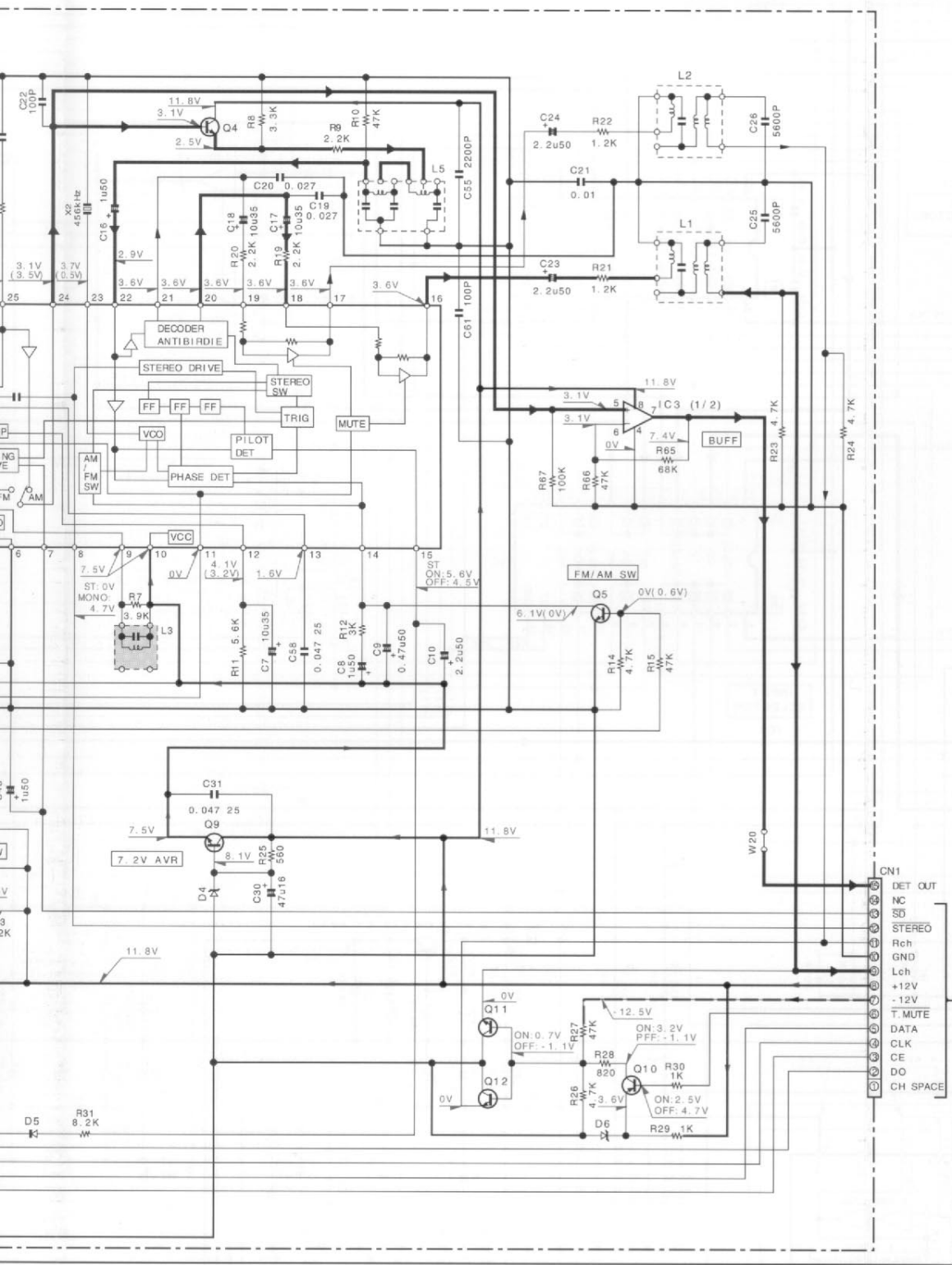

CAUTION: For continued protection against electric shock, leakage-current measurement value may vary from the supply circuit) before the customer.

The DC voltage is an actual impedance type voltmeter measurement value may vary from the instruments used or on the part.

2SC1845
2SC3940A
2SD863

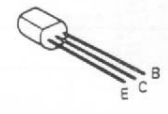

2SC1740S

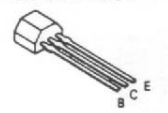

2SB1370
2SD2061

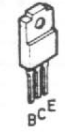

NJM2120D
NJM4565D
NJM4565D-D

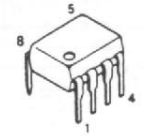

	L6	Q6	D10	R59, 60	W107, 113, 204
(B)	L39-1328	NO	NO	NO	NO
(A)	L39-1325	YES	YES	YES	YES

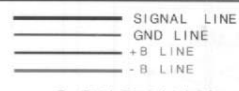

C-G7/G72(1/3)

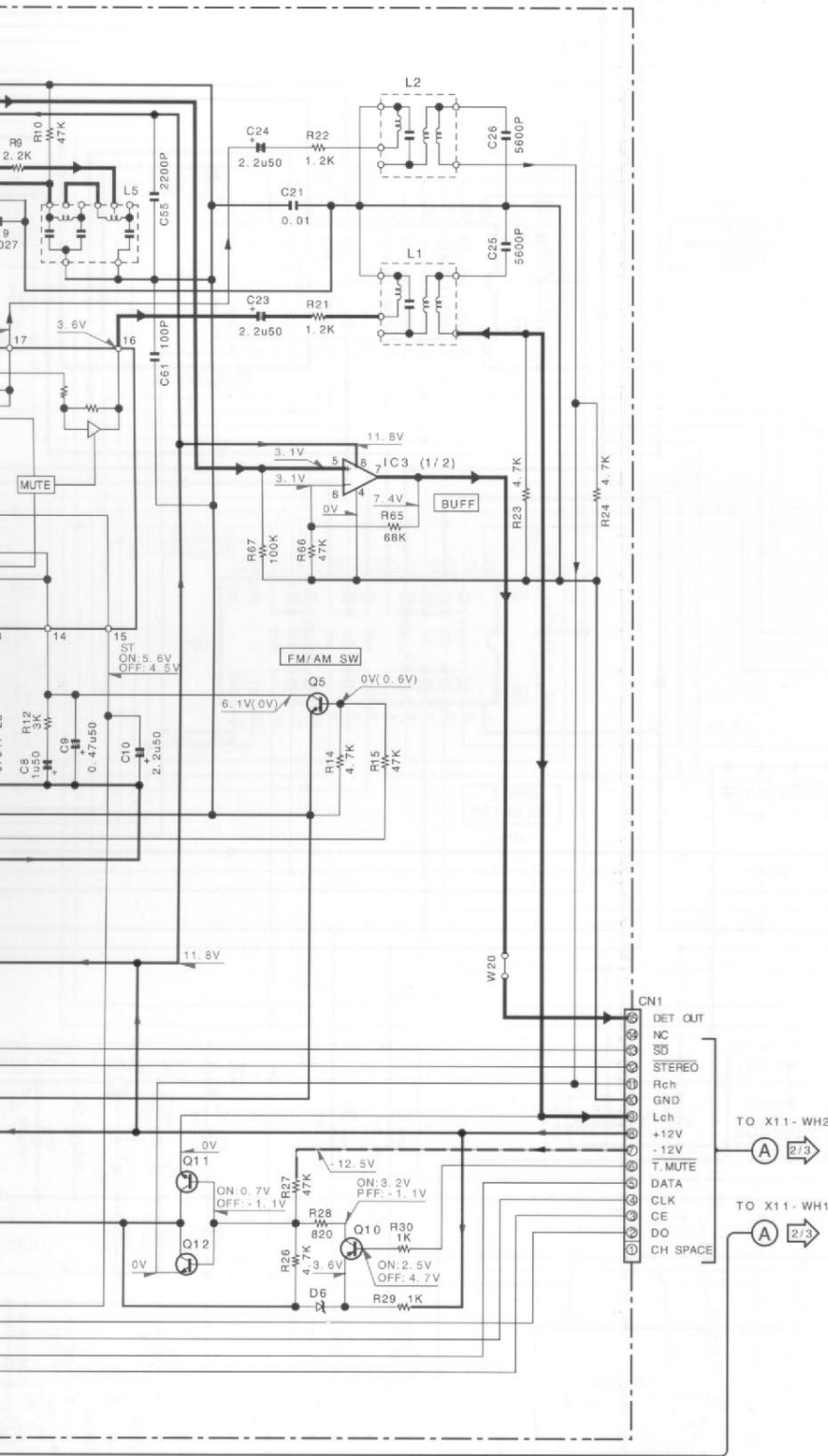

07, 113, 204
NO
YES

——— SIGNAL LINE
 ——— GND LINE
 ——— +B LINE
 ——— -B LINE
 C-G7/G72(1/3)

CAUTION: For continued safety, replace safety critical components only with manufacturer's recommended parts (refer to parts list). Δ indicates safety critical components. For continued protection against risk of fire, replace only with same type and rating fuse(s). To reduce the risk of electric shock, leakage-current or resistance measurements shall be carried out (exposed parts are acceptably insulated from the supply circuit) before the appliance is returned to the customer.

The DC voltage is an actual reading measured with a high impedance type voltmeter with no signal input. The measurement value may vary depending on the measuring instruments used or on the product.

2SC1845
2SC3940A
2SD863

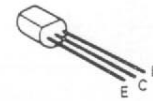

2SC2785

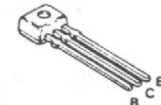

2SC1740S

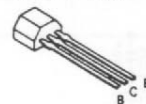

2SA1037K
2SA1576
2SC2412K
2SC2714
2SC4081
2SD1757K



2SB1370
2SD2061



2SB1375
2SD2012



NJM2120D
NJM4565D
NJM4565D-D

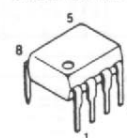

NJM2279D

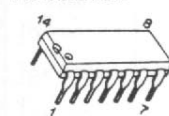

C-G7/G72

KENWOOD

Y08-4532-70

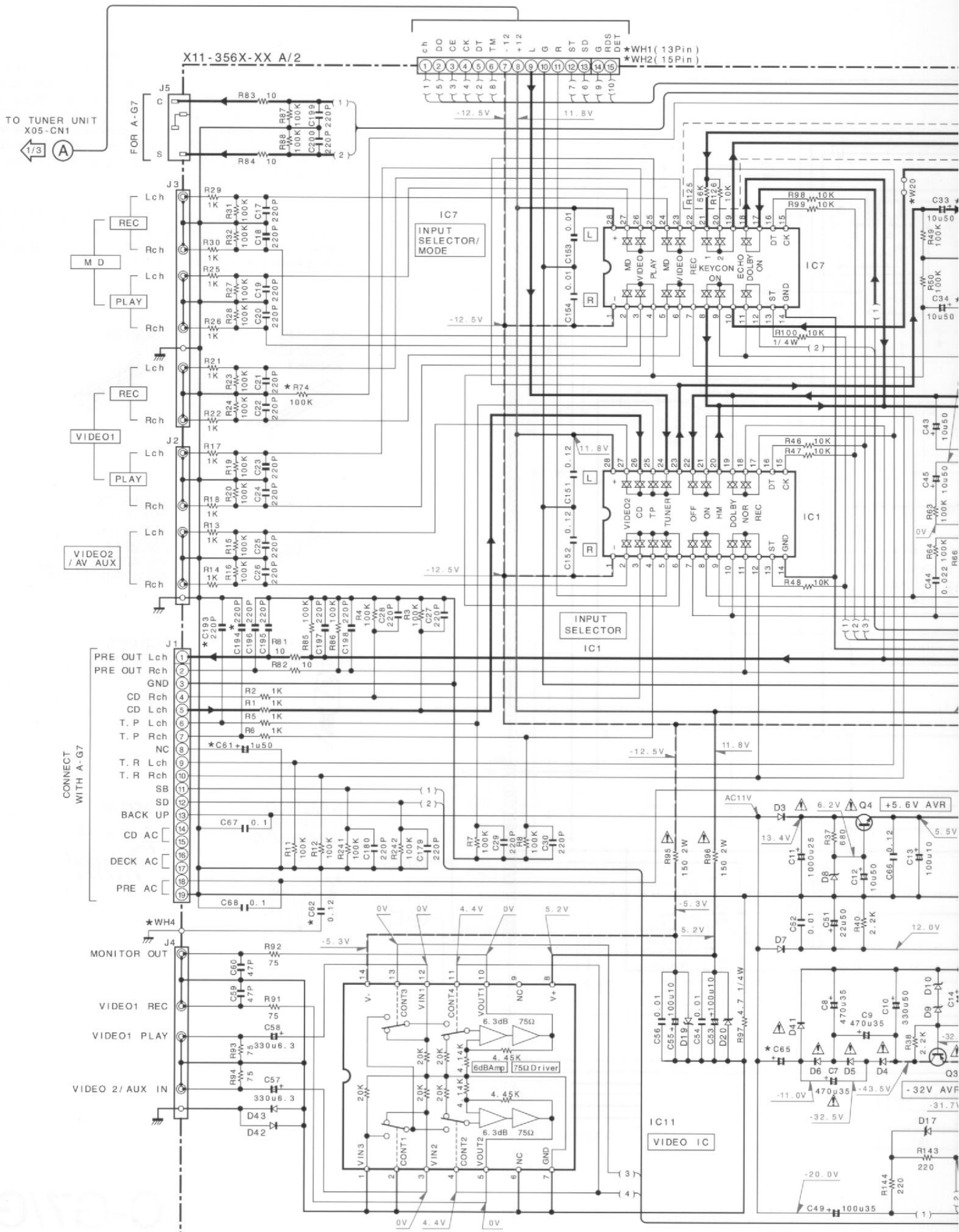

X11-356X-XX A/2

1 ch 2 DO 3 CE 4 CK 5 DT 6 TM 7 L 8 G 9 R 10 ST 11 SD 12 BPS 13 DET 14 15
 *WH1 (13Pin)
 *WH2 (15Pin)

TO TUNER UNIT
 X05-CN1
 1/3 A

IC7
INPUT SELECTOR/
MODE

INPUT
SELECTOR
IC1

IC11
VIDEO IC

CONNECT
 WITH A-G7

PRE OUT Lch
 PRE OUT Rch
 GND
 CD Rch
 CD Lch
 T. P Lch
 T. P Rch
 NC
 T. R Lch
 T. R Rch
 SB
 SD
 BACK UP
 CD AC
 DECK AC
 PRE AC

*WH4
 MONITOR OUT
 VIDEO1 REC
 VIDEO1 PLAY
 VIDEO 2/ AUX IN

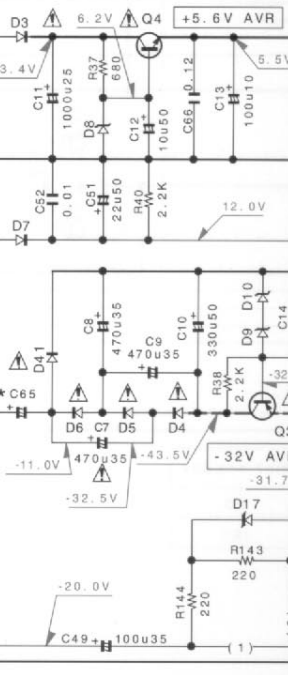
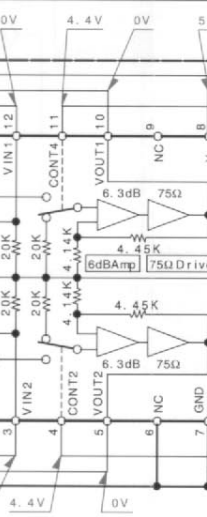

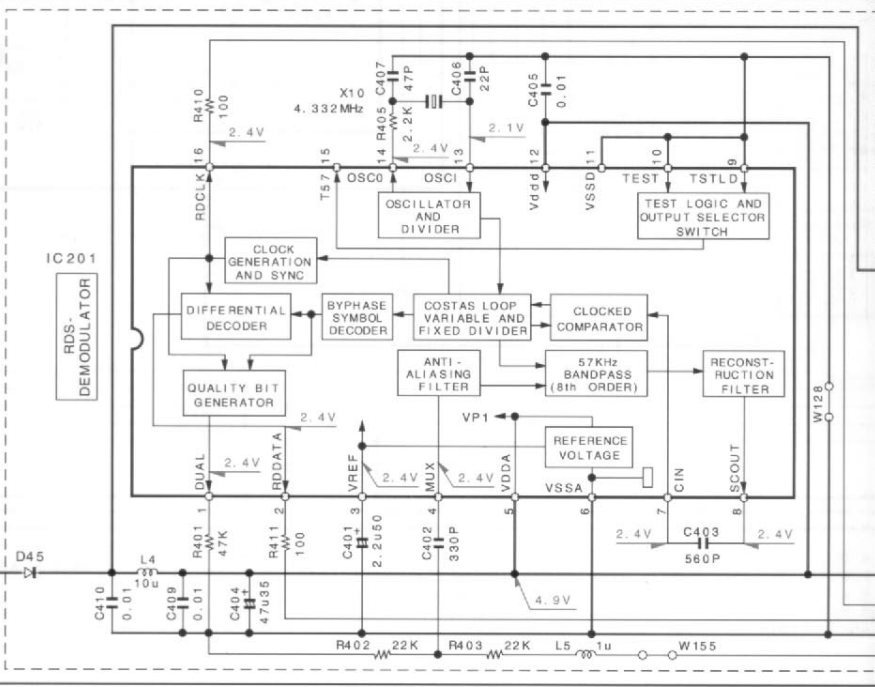
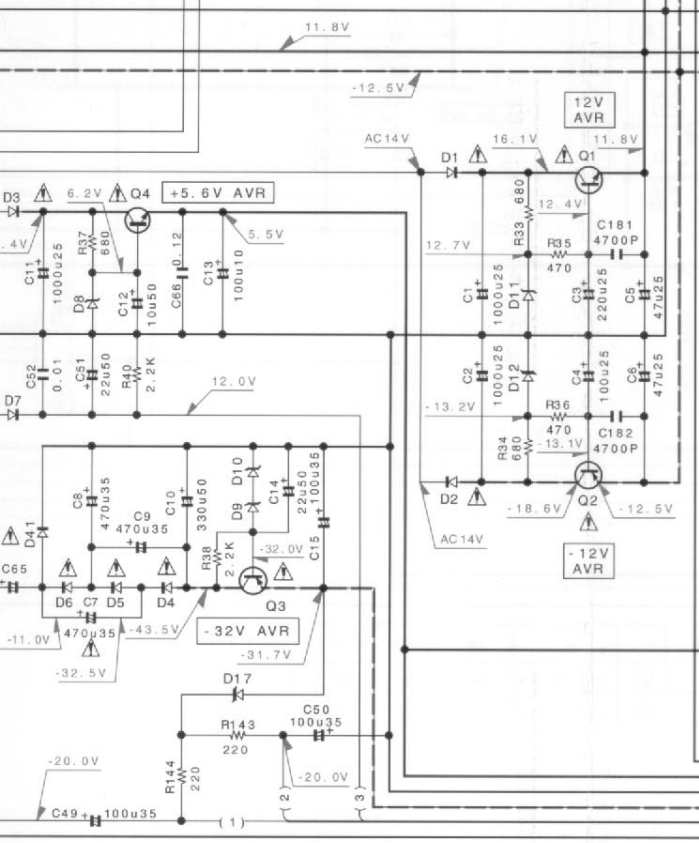
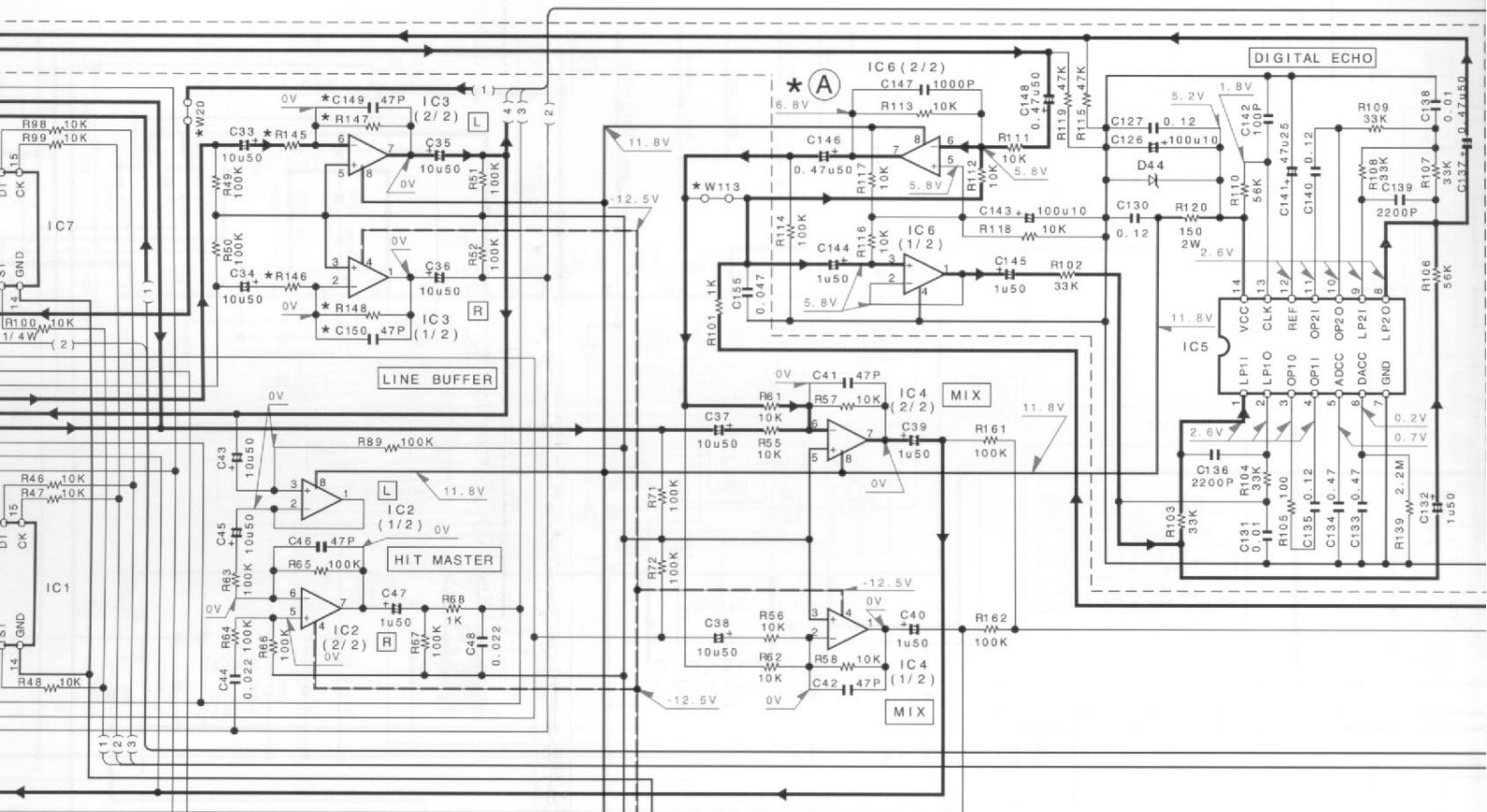

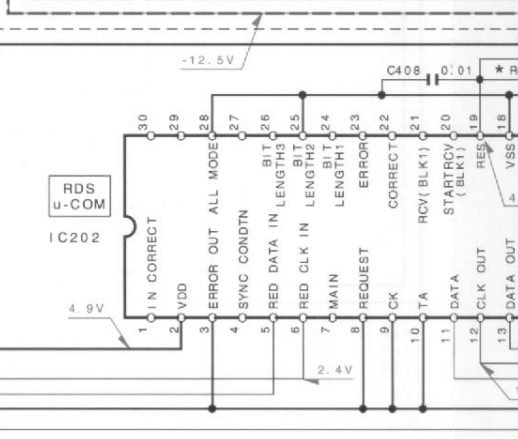
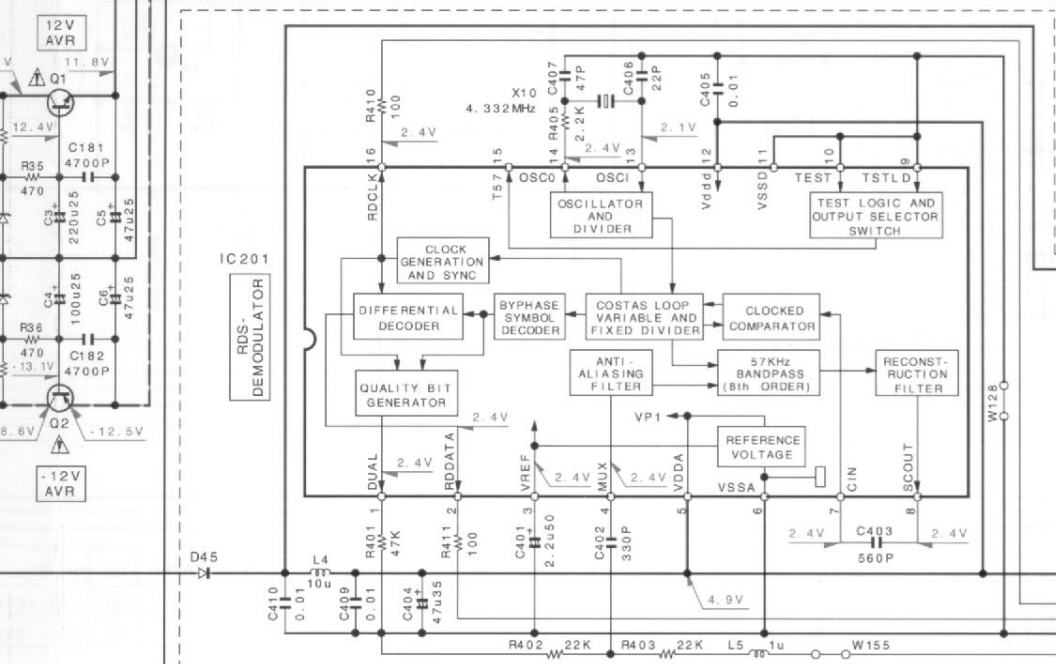
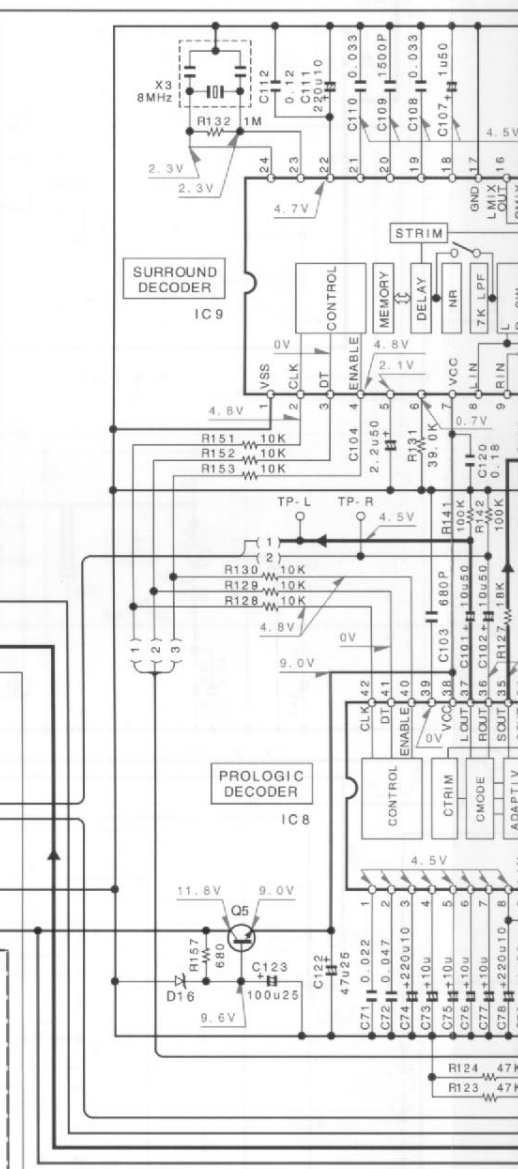
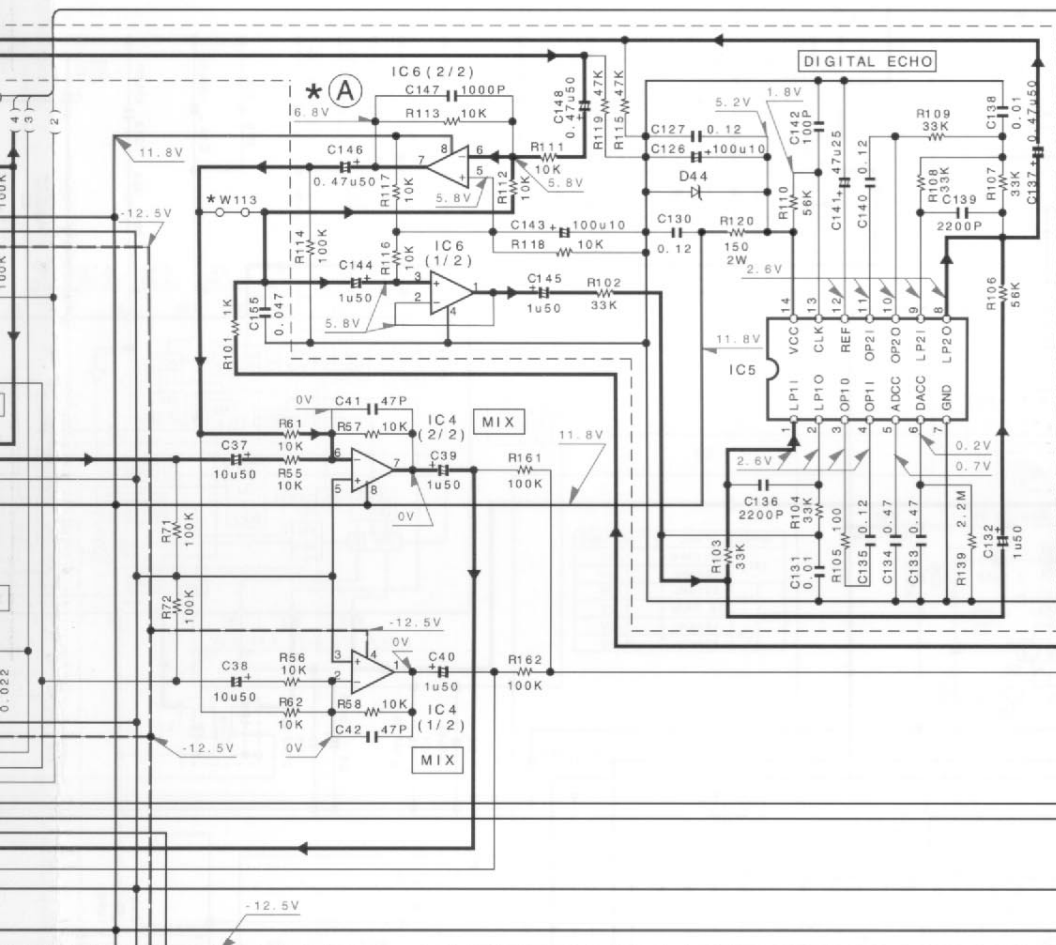

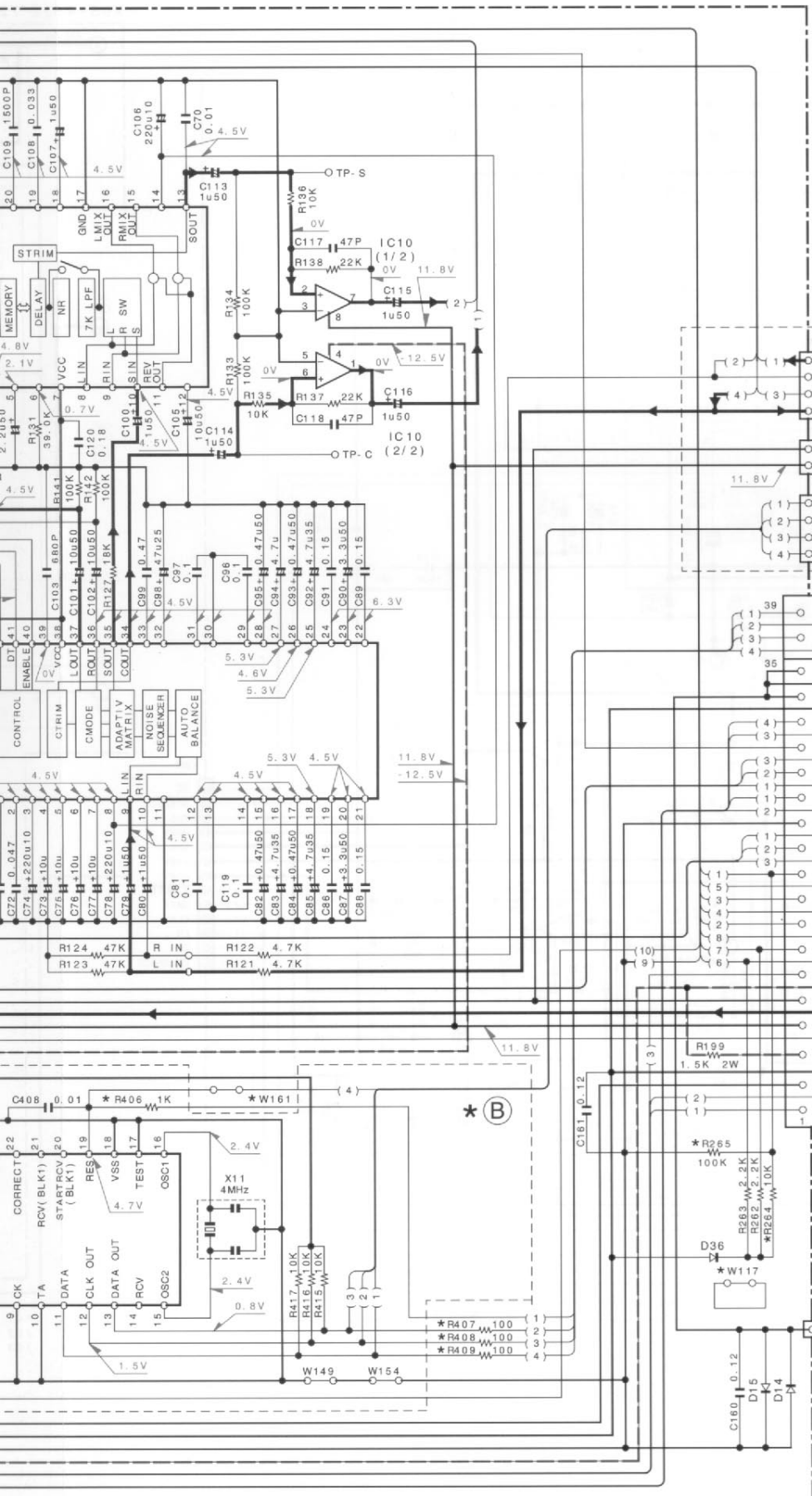

- IC1 : NJU7313AL or TC9164N
- IC2, 10 : NJM4565L-D
- IC3, 4, 6 : XRA15218-DX or NJM4565D-D
- IC5 : M65844P
- IC7 : NJU7311AL or TC9162N
- IC8 : LA2785
- IC9 : LV1011
- IC11 : NJM2279D
- IC201 : SAA6579
- IC202 : LC6543H-4D68

- Q1, 4 : 2SD2061 or 2SD2012
- Q2, 3 : 2SB1370 or 2SB1375
- Q5 : 2SC3940A or 2SD863(E,F)

- D1-6, 41 : S5688B or 1SR139-100
- D7, 14, 15, 36, 42, 43, 45 : 1SS131 or HSS104A
- D8 : RD6.2ES(B2) or HZS6.2N(B2) or U
- D9, 10, 17 : RD16ES(B2) or HZS16N(B2) or U
- D11, 12 : RD13ES(B2) or HZS13N(B2) or U
- D16 : RD10ES(B2) or HZS10N(B2) or U
- D19, 20, 44 : RD5.1ES(B2) or HZS5.1N(B2) or U

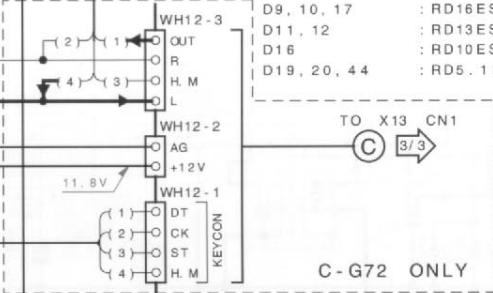

C-G72 ONLY



X11 - A/2

MODEL NAME	DESTINATION		UNIT NO.	R264	R265
	COUNTRY	ABB.			
C-G7	EUROPE	E	2-71	YES	NO
	PX	Y	0-22		
	GENERAL MARKET	M	3-01		
	CHI NA	C	3-01		
C-G72	AUSTRALIA	X	0-72	NO	YES
	ENGLAND	T	0-52		
	GENERAL MARKET	M	0-23	YES	NO

X11 - A/2

MODEL NAME	DESTINATION		UNIT NO.	CN2	C65	C193, C194	C149, C150	R145, R146
	COUNTRY	ABB.						
C-G7	EUROPE	E	2-71	39	470u35	YES	NO	100K
	PX	Y	0-22					
	GENERAL MARKET	M	3-01	35	220u35	NO	YES	10K
	CHI NA	C	3-01					
C-G72	AUSTRALIA	X	0-72		470u35	YES	NO	100K
	ENGLAND	T	0-52					
	GENERAL MARKET	M	0-23	39	220u35	NO	YES	10K



C-G7/G72 (2/3)

TC9164N
 NJM4565D-D
 TC9162N

SD2012
 SB1375
 2SD863(E, F)
 R139-100

S104A
 or HZS6.2N(B2) or UZ-6.2BSB
 or HZS16N(B2) or UZ-16BSB
 or HZS13N(B2) or UZ-13BSB
 or HZS10N(B2) or UZ-10BSB
 or HZS5.1N(B2) or UZ-5.1BSB

CAUTION: For continued safety, replace safety critical components only with manufacturer's recommended parts (refer to parts list). Δ indicates safety critical components. For continued protection against risk of fire, replace only with same type and rating fuse(s). To reduce the risk of electric shock, leakage-current or resistance measurements shall be carried out (exposed parts are acceptably insulated from the supply circuit) before the appliance is returned to the customer.

The DC voltage is an actual reading measured with a high impedance type voltmeter with no signal input. The measurement value may vary depending on the measuring instruments used or on the product.

XR-1091ECP

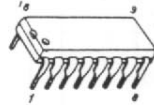

SAA6579



M5223P
 XRA15218-DX

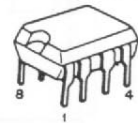

LA2785L

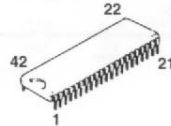

LA1836

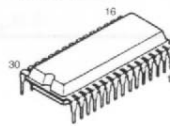

M65840SP
 TC9162N
 TC9164N

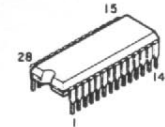

NJM4565L-D

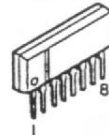

LC7218
 LV1011L

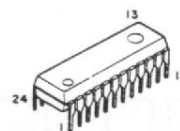

NJU7311AL
 NJU7313AL

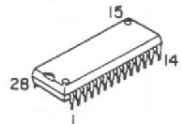

M65844P

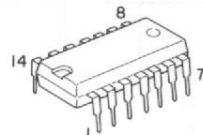

UNIT NO.	R264	R265	(A)	(B)	C61 C62 WH2	W113	WH1	WH2 WH4
2-71			NO	YES	YES	NO	YES	YES
0-22	YES	NO	YES	NO	NO	YES	NO	NO
3-01								
0-72	NO	YES	NO	YES	YES	NO	YES	NO
0-52								
0-23	YES	NO	YES	NO	NO	YES	NO	NO
	DSW1-O	DSW1-1	ECHO	RDS	ECHO	RDS	RDS	RDS
	YES	YES	YES	YES	NO	NO	YES	YES

C65	C193, C194	C149, C150	R145, R146	R147, R148	W20, W161	R406- 409	R74
0u35	YES	NO	100K	120K		YES	
0u35	NO	YES	10K	12K	NO	NO	YES
0u35	YES	NO	100K	120K		YES	
0u35	NO	YES	10K	12K	YES	YES	NO
					KEYCON	RDS YES	KEYCON
					YES	KEYCON YES	NO

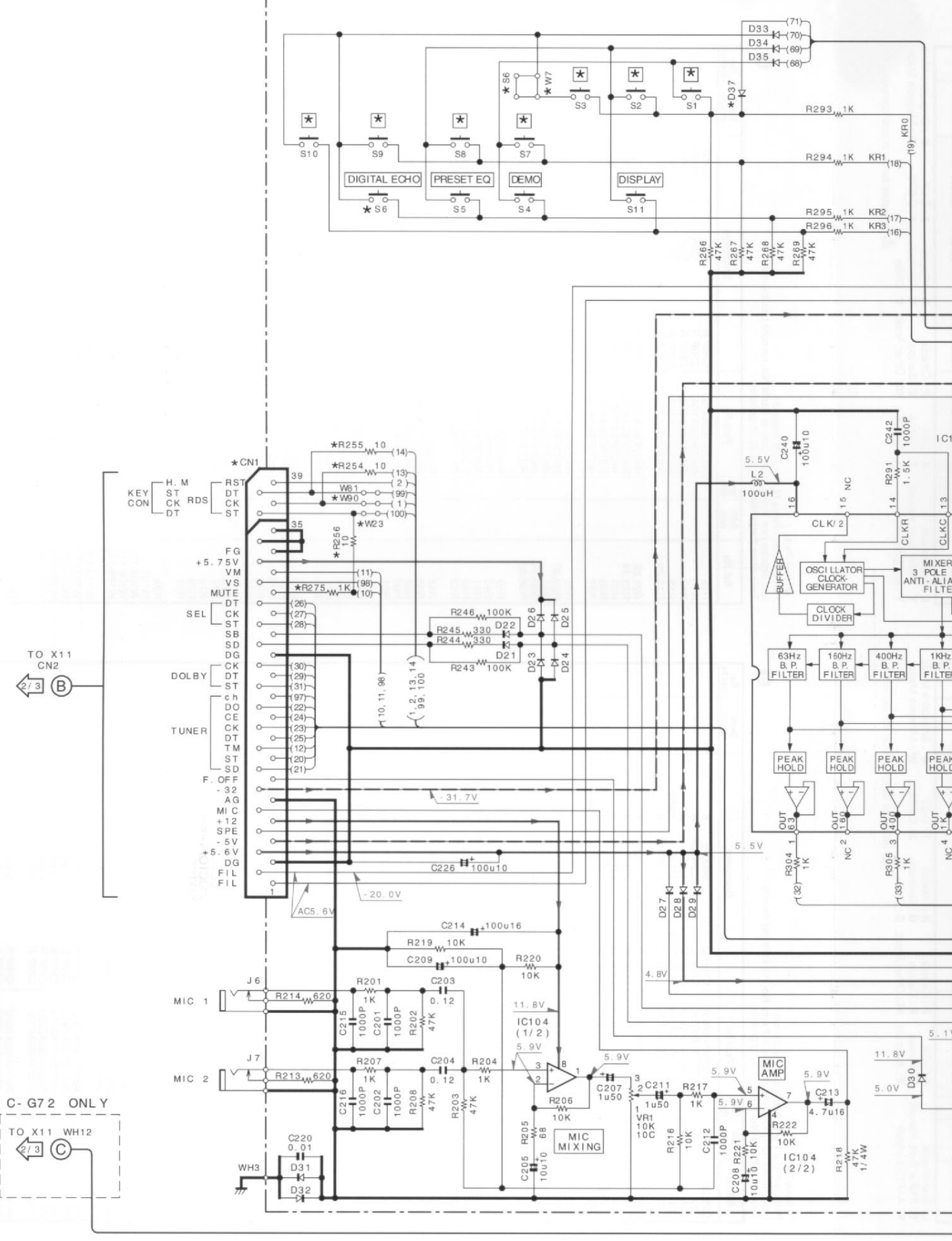

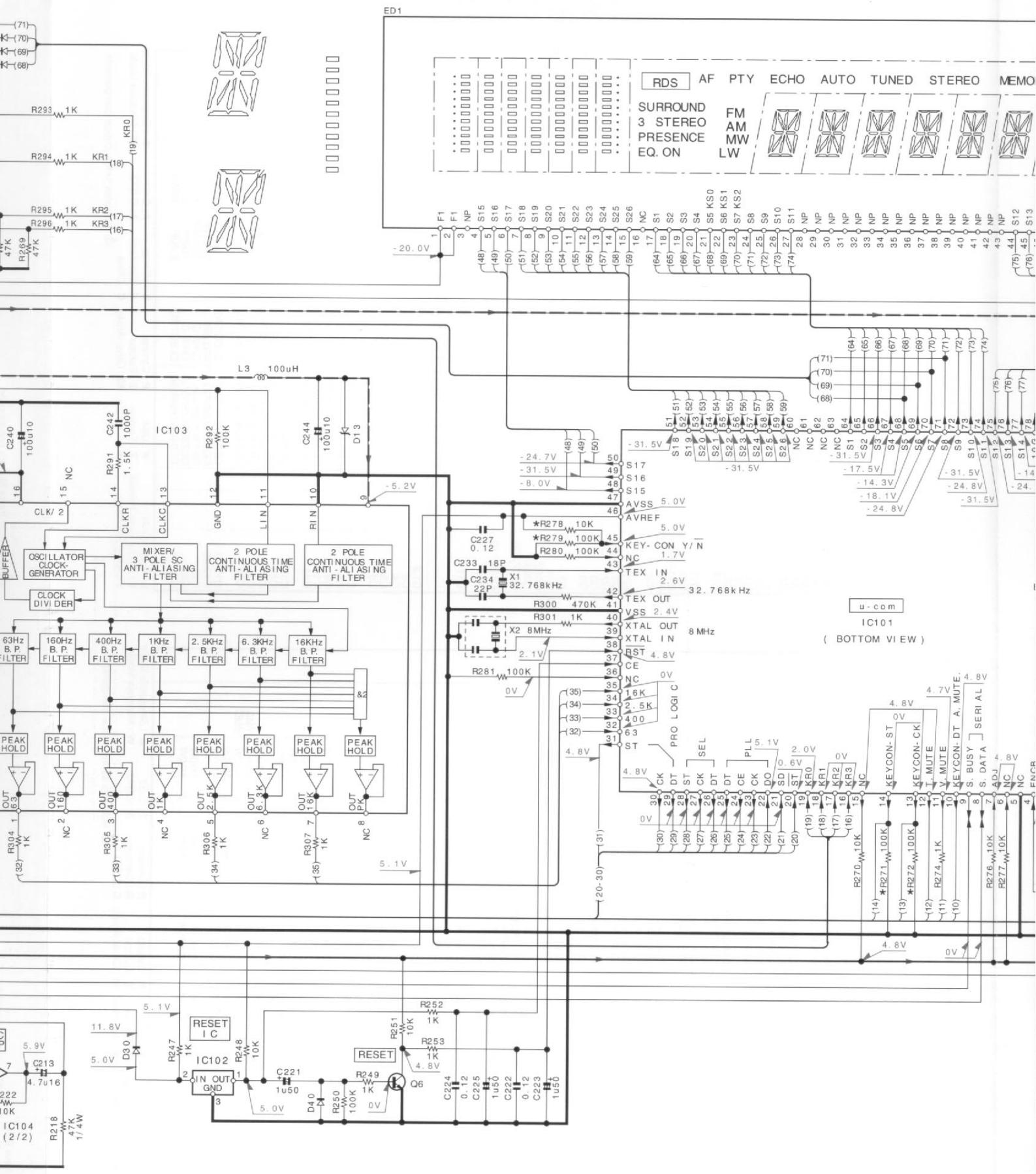

u-com IC101 (BOTTOM VIEW)

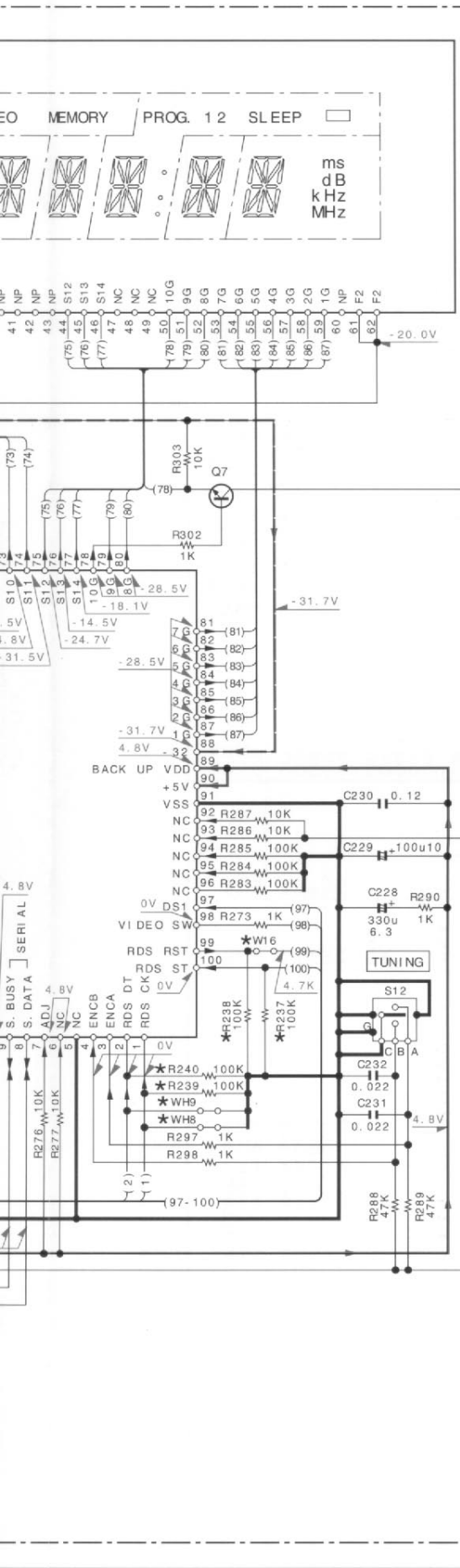

- ED1 : FIP10EMW6R
- IC101 : CXP82440A-116Q(C-G7 ONLY)
CXP82440A-131Q(C-G72 ONLY)
- IC102 : PST9140-T
- IC103 : XR-1091ECP
- IC104 : NJM4565L-D
- Q6,7 : 2SC1740S(Q,R) or 2SC2785(F,E)
- D13 : RD5.1ES(B2) or HZS5.1N(B2) or UZ-5.1BSB
- D21-35,37,40 : 1SS131 or HSS104A

X11-B/2

MODEL NAME	DESTINATION		UNIT NO.	D37	S6	W7	W23	R239 R240	CN1	R278 R254-256 WH8,9	R271,272 R275,279 W81,90	RDS KEYC
	COUNTRY	ABB.										
C-G7	EUROPE	E	2-71	NO	NO	YES	YES	NO	39	NO	YES	
	PX	Y	0-22	YES	YES	NO	NO	YES	35			
	GENERAL MARKET	M	3-01									
	CHINA	C	0-72									
	AUSTRALIA	X	0-52									
C-G72	ENGLAND	T	0-52	NO	NO	YES	YES	NO	39	YES	NO	
	GENERAL MARKET	M	0-23	YES	YES	NO	NO	NO	39	YES	NO	
				DSWO	ECHO YES	ECHO NO	RDS YES	KEYCON RDS NO		KEYCON YES	KEYCON NO	RDS KEYC

- IC21 : M65840SP
- IC22 : NJM2120D
- Q10 : 2SC2940A(R,S) or 2SD863(E,F)
- Q11 : 2SC2785(F,E) or 2SC1740S(Q,R)
- D50 : MTZJ5.6(B) or UZ-5.6BSB
- D51 : MTZJ10(B) or UZ-10BSB

X13-7390-20 (C-G72 ONLY)

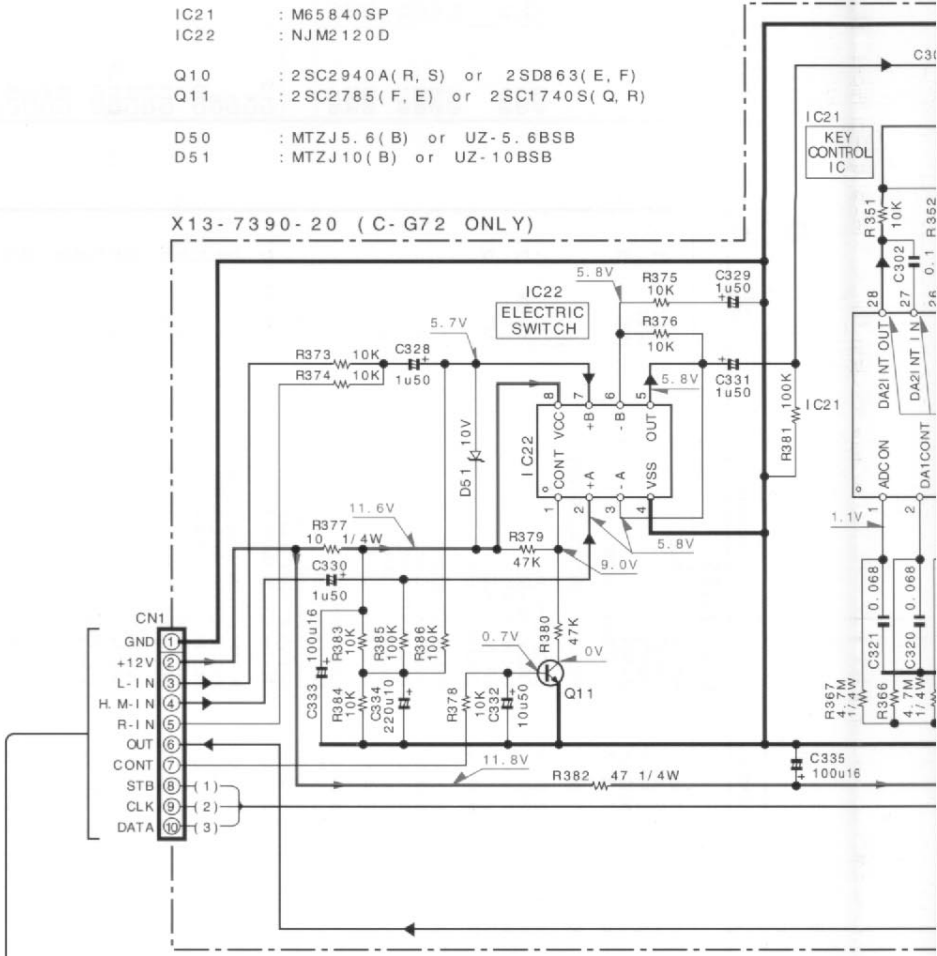

CAUTION: For continued safety, replace components only with manufacturer's (refer to parts list). Δ indicates safety. For continued protection against risk with same type and rating fuse(s). To avoid electric shock, leakage-current or risk shall be carried out (exposed parts are from the supply circuit) before the appliance is returned to the customer.

The DC voltage is an actual reading with an impedance type voltmeter with no measurement value may vary depend on the instruments used or on the product.

R271, 272 R275, 279 W81, 90	W16	R237, R238	S1	S2	S3	S7	S8	S9	S10
YES	NO	YES	AUTO	BAND	PRESENCE	OFF	DOLBY 3 STEREO	DOLBY PRO LOGIC	CENTER MODE
NO	YES	NO	# / AUTO	b / BAND	KEY CON	PRESENCE	OFF	DOLBY 3 STEREO	DOLBY PRO LOGIC
KEYCON NO	RDS YES KEYCON YES	RDS NO							

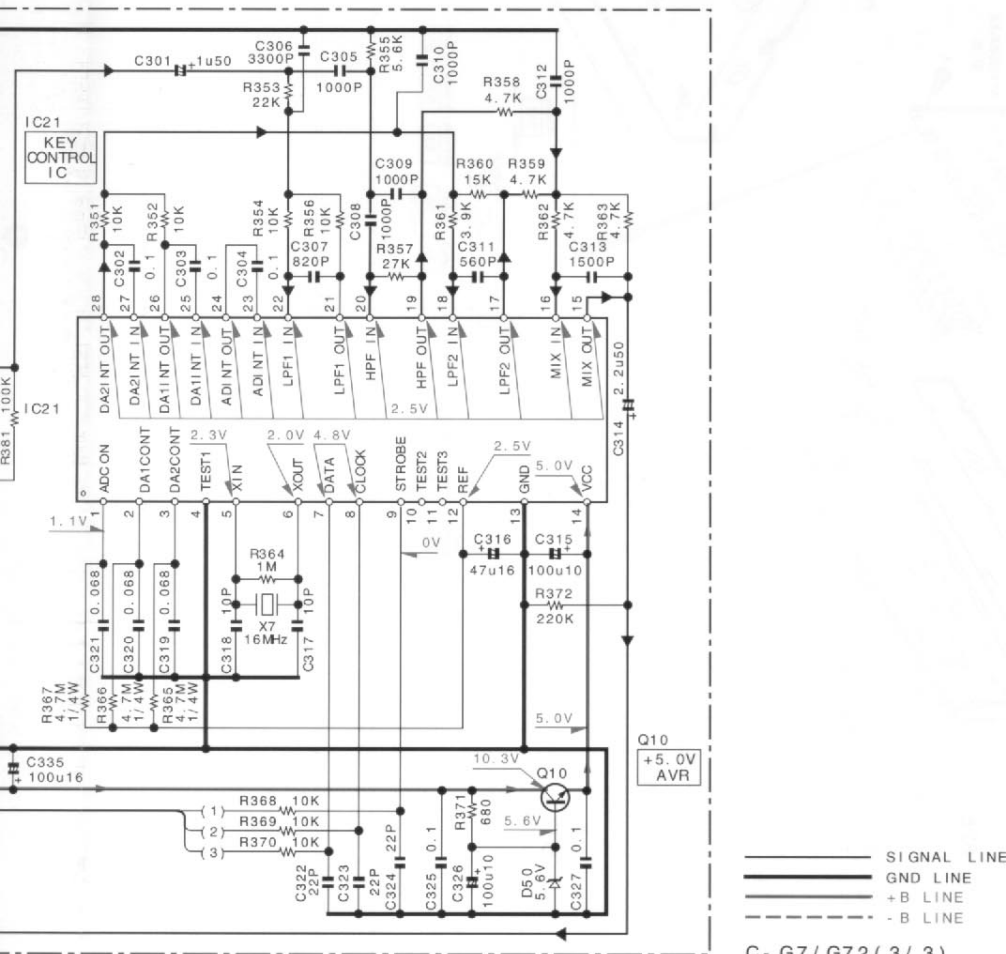

C- G7 / G72 (3 / 3)

CAUTION: For continued safety, replace safety critical components only with manufacturer's recommended parts (refer to parts list). Δ indicates safety critical components. For continued protection against risk of fire, replace only with same type and rating fuse(s). To reduce the risk of electric shock, leakage-current or resistance measurements shall be carried out (exposed parts are acceptably insulated from the supply circuit) before the appliance is returned to the customer.

The DC voltage is an actual reading measured with a high impedance type voltmeter with no signal input. The measurement value may vary depending on the measuring instruments used or on the product.

S2	S3	S7	S8	S9	S10
BAND	PRESENCE	OFF	DOLBY 3 STEREO	DOLBY PRO LOGIC	CENTER MODE
b / BAND	KEY CON	PRESENCE	OFF	DOLBY 3 STEREO	DOLBY PRO LOGIC

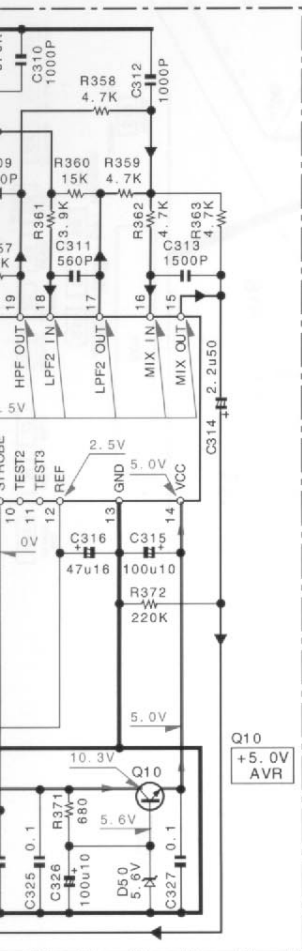

——— SIGNAL LINE
 = = = GND LINE
 - - - +B LINE
 - - - -B LINE

C- G7 / G72 (3 / 3)

C-G7/G72

KENWOOD

Y08-4532-70

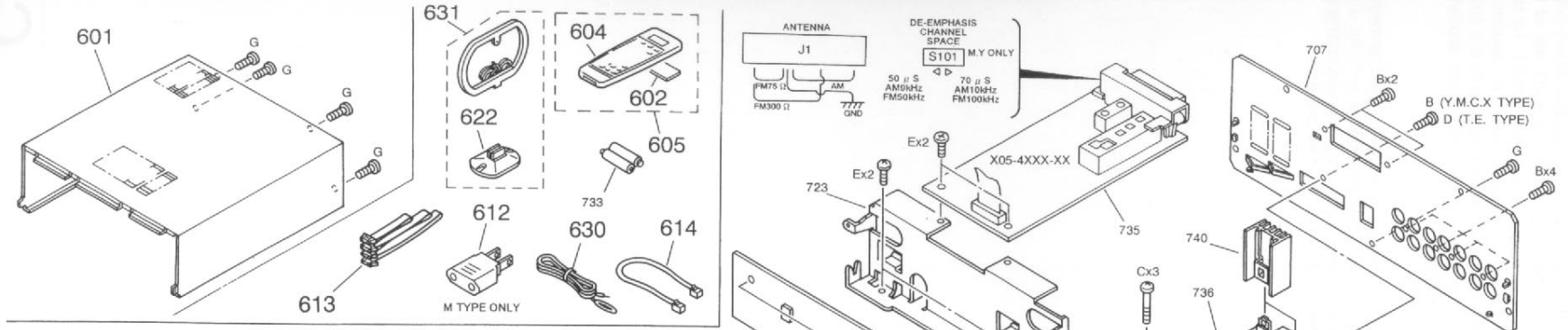

- A ϕ 2.6x8 (Bi-Tap) :N82-2608-46
- B ϕ 3x8 (Bi-Tap) BLK :N89-3008-45
- C ϕ 3x23 (Bi-Tap) :N89-3023-46
- D ϕ 3x19 :N09-0292-05
- E ϕ 3x8 (Bi-Tap) :N89-3008-46
- F ϕ 3x10 (Bi-Tap) BLK :N89-3010-45
- G ϕ 3x6 :N09-0395-05

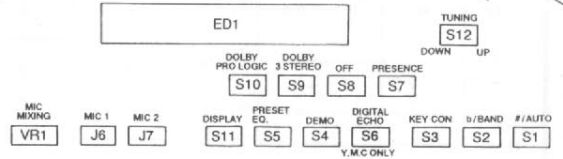
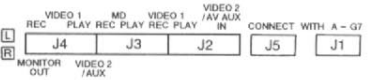
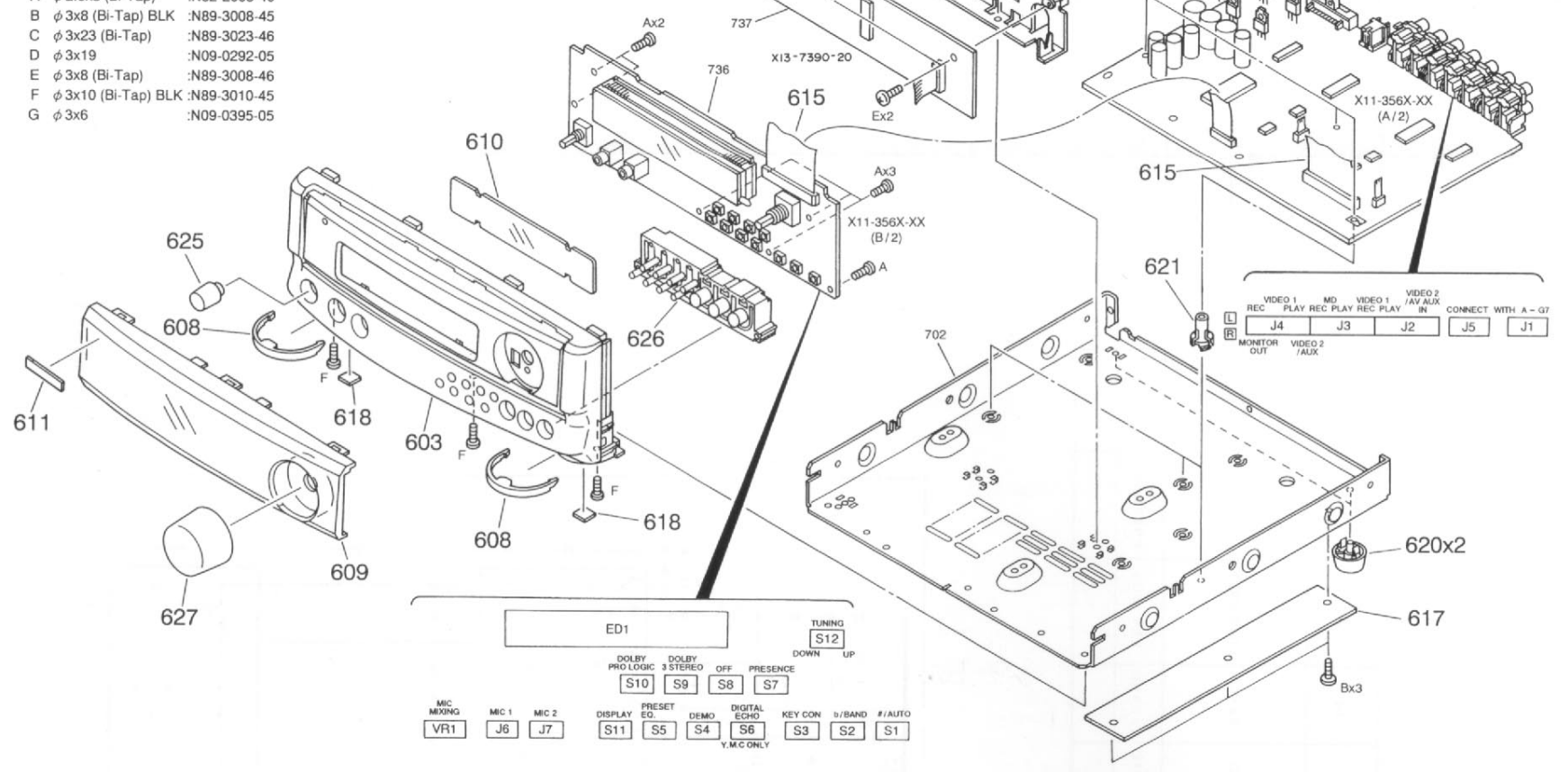

Parts with the exploded numbers larger than 700 are not supplied.

* New Parts

C-G7/G72

SPECIFICATIONS

FM tuner section

Tuning frequency range.....87.5 MHz ~ 108 MHz
Sensitivity (IHF)13.2 dBf (1.2 μ V at 75 Ω)
Signal to noise ratio (at 1 kHz)
MONO.....75 dB (65 dBf input)
STEREO.....68 dB (65 dBf input)
Selectivity (IHF \pm 400 kHz).....50 dB
Stereo separation (IHF at 1 kHz)40 dB
Frequency response30 Hz ~ 15 kHz, +0.5 dB, -3 dB

AM tuner section

Tuning frequency range
9 kHz step531 kHz ~ 1,602 kHz
10 kHz step530 kHz ~ 1,610 kHz
Usable sensitivity12 μ V / (500 μ V / m)
Signal to noise ratio48 dB

General

Dimensions.....W : 270 mm (10 -5/8")
H : 104 mm (4 -1/8")
D : 334 mm (13 -1/8")
Weight (Net)2.0 kg (4.4 lb)

KENWOOD follows a policy of continuous advancements in development. For this reason specifications may be changed without notice.

Note:

Component and circuitry are subject to modification to insure best operation under differing local conditions. This manual is based on the U.S.A. (K) standard, and provides information on regional circuit modification through use of alternate schematic diagrams, and information on regional component variations through use of parts list.

KENWOOD CORPORATION

14-6,Dogenzaka 1-chome, Shibuya-ku, Tokyo, 150 Japan

KENWOOD SERVICE CORPORATION

P.O BOX 22745, 2201 East Dominguez St., Long Beach, CA 90801-5745, U.S.A.

KENWOOD ELECTRONICS CANADA INC.

6070 Kestrel Road, Mississauga, Ontario, Canada L5T 1S8

KENWOOD ELECTRONICS LATIN AMERICA S.A.

P.O BOX 55-2791, Piso 6 plaza Chase, Cl. 47 y Aquilino de la Guardia Panama, Republic de Panama

KENWOOD ELECTRONICS U.K. LIMITED

KENWOOD House, Dwight Road, Watford, Herts., WD1 8EB., United Kingdom

KENWOOD ELECTRONICS BENELUX N.V.

Meachelsesteenweg 418, B-1930 Zaventem, Belgium

KENWOOD ELECTRONICS DEUTSCHLAND GMBH

Pembrücker Str. 15, 63150 Heusenstamm, Germany

KENWOOD ELECTRONICS FRANCE S.A.

13 Boulevard Ney, 75018 Paris, France

KENWOOD ELECTRONICS ITALIA S.p.A.

Via G. Sirtori, 7/9 20129, Milano, Italy

KENWOOD IBÉRICA S.A.

Bolivia, 239-08020 Barcelona, Spain

KENWOOD ELECTRONICS AUSTRALIA PTY. LTD. (A.C.N. 001499 074)

P.O Box 504, 8 Figtree Drive, Australia Centre, Homebush, N.S.W. 2140, Australia

KENWOOD & LEE ELECTRONICS, LTD.

Unit 3712-3724, Level 37, Tower 1, Metroplaza, 223 Hing Fong Road, Kwai Fong N.T., Hong Kong

KENWOOD ELECTRONICS SINGAPORE PTE LTD.

No. 1 Genting Lane #02-02, KENWOOD Building, Singapore, 349544

KENWOOD ELECTRONICS (MALAYSIA) SDN BHD.

#4.01 Level 4, Wisma Academy Lot 4A, Jalan 19/1 46300 Petaling Jaya Selangor Darul Ehsan Malaysia